



IMPORTANT SAFETY INSTRUCTIONS SAVE THESE INSTRUCTIONS

PLEASE READ THE ENTIRE CONTENTS OF THIS MANUAL PRIOR TO INSTALLATION AND OPERATION. BY PROCEEDING WITH THIS 3-D ALIGNER INSTALLATION AND OPERATION YOU AGREE THAT YOU FULLY UNDERSTAND AND COMPREHEND THE FULL CONTENTS OF THIS DOCUMENT. FORWARD THIS IMPORTANT MANUAL TO ALL OPERATORS.

Revision A 02-23-16
P/N 5900963

OPERATION MANUAL

**MODEL: 3DP4100
TARGET 3D PRO
WHEEL ALIGNMENT SYSTEM**

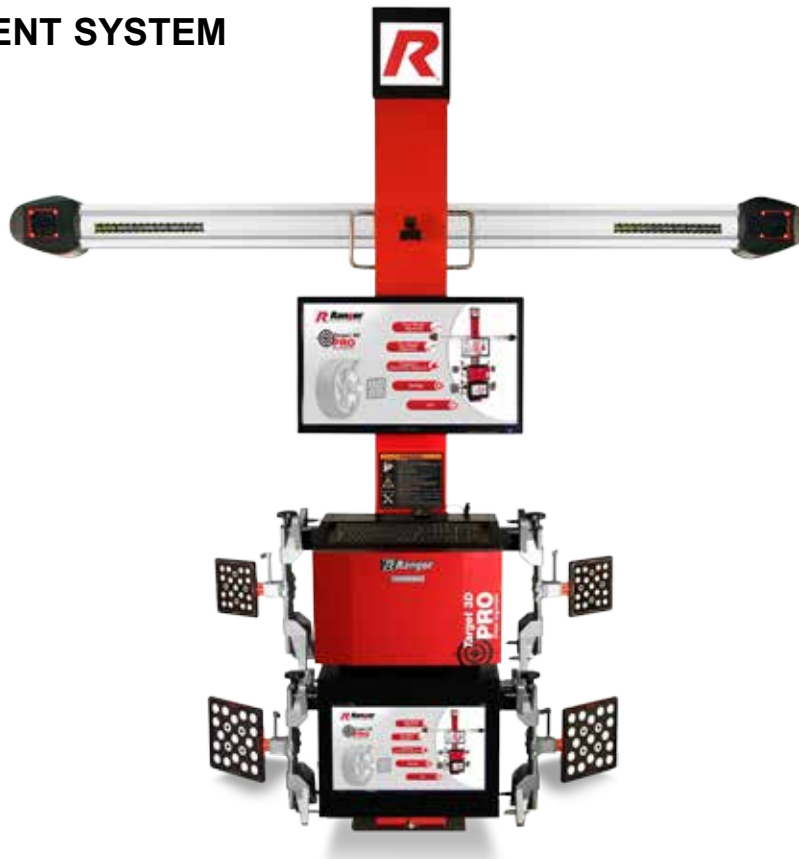

READ FIRST



Do not operate this machine until you read and understand all the dangers, warnings and cautions in this manual.

RECEIVING

The shipment should be thoroughly inspected as soon as it is received. The signed Bill of Lading is acknowledgement by the shipping carrier as receipt of this product as listed in your invoice as being in a good condition of shipment. If any of these goods listed on this Bill of Lading are missing or damaged, do not accept merchandise until the shipping carrier makes a notation on the freight bill of the missing or damaged goods. Do this for your own protection.

BE SAFE

Your new alignment system was designed and built with safety in mind. However, your overall safety can be increased with proper training and thoughtful operation on the part of the operator. DO NOT operate or repair this equipment without reading this manual and the important safety instructions shown inside. Keep this operation manual near the alignment system at all times. Make sure that ALL USERS read and understand this manual.



1645 Lemonwood Dr.
Santa Paula, CA. 93060, USA
Toll Free 1-800-253-2363
Tel: 1-805-933-9970
Fax: 1-805-933-9160
www.bendpak.com

TABLE OF CONTENTS

Product Warranty	3
Definitions of Hazard Levels	4
Important Safety Instructions	5 - 7
Owner's Responsibility	7
Installation Location	8
System Requirements	9
Alignment Angles	10 - 12
Preparation Before Alignment	13 - 14
Cameras and Target Position	15
Adjusting Camera Beam	15
Camera LED Indicators	15 - 16
Installing Clamps	17
Before Measurement	18
Measurement Results	19
Adjusting Screen Buttons	20
Search Targets	21
Lifting Instructions	22
Target Blocked Indicators	23
Software Program Navigation	24
Keyboard Navigation	24
Search Targets Screen of Fixed Version 3D alignment	25
Target Gray Values Adjustment	26
Gray Values Front & Rear Targets	27
Measurement Procedures	28 - 33
Measurement Ways	33 - 34
Targets Exposure Values Adjustment	34 - 35
Super Measurement	36 - 37
Conventional Measurement	38 - 41
Single Direction Measurement	41 - 43
Short Distance Measurement	43 - 47
Lift Measurement	47 - 53
Caster Measurement	53 - 61
Straighten the Steering Wheel by Eye	61 - 63
Report Before Adjustment	63
Adjustment and Widgets	64 - 65
Oil Gauge Status	66
Digital Type Status Explanation	67
Enlarge Adjustment Values	68
Unit Convert	68
Degree and Minute Unit Convert	69
Toe Unit Convert	69 - 70
Summary Measurement Values	71
Caster Adjustment	72
Rear Wheels Adjustment	72 - 75
Lift Adjustment	75 - 76
Single Wheel Measurement	77 - 79
Front Wheels Adjustment	80 - 81
Front Wheels Adjustment - Steering Wheel Adjustment	82 - 85
Front Wheels Adjustment - Camber at Zero Toe	86 - 89
Report After Adjustment	89
System Maintenance	90 - 97
Camera Calibration	97
Camera Test	116
Add Vehicle Specification	117 - 125
Troubleshooting	126 - 128

READ THIS ENTIRE MANUAL BEFORE OPERATION BEGINS

RECORD HERE THE FOLLOWING INFORMATION
WHICH IS LOCATED ON THE SERIAL NUMBER DATA TAG

Model No.	
Revision	
Serial No.	
Date of Mfg.	
Voltage	
Key No.	

PRODUCT WARRANTY

Your new alignment system is warranted for one year on equipment structure; one year on all operating components and tooling/accessories, to the original purchaser, to be free of defects in material and workmanship. The manufacturer shall repair or replace at their option for this period those parts returned to the factory freight prepaid which prove upon inspection to be defective. The manufacturer will pay labor costs for the first 12 months only on parts returned as previously described.

The warranty does not extend to:

1. Defects caused by ordinary wear, abuse, misuse, shipping damage, improper installation, voltage or lack of required maintenance.
2. Damages resulting from purchaser's neglect or failure to operate products in accordance with instructions provided in the owner's manual(s) and/or other accompanying instructions supplied.
3. Normal wear items or service normally required to maintain the product in a safe operating condition.
4. Any component damaged in shipment.
5. Other items not listed but may be considered general wear parts.
6. Damage caused by rain, excessive humidity, corrosive environments or other contaminant's.

THESE WARRANTIES DO NOT EXTEND TO ANY COSMETIC DEFECT NOT INTERFERING WITH EQUIPMENT FUNCTIONALITY OR ANY INCIDENTAL, INDIRECT, OR CONSEQUENTIAL LOSS, DAMAGE, OR EXPENSE THAT MAY RESULT FROM ANY DEFECT, FAILURE, OR MALFUNCTION OF A BENDPAK INC./ RANGER PRODUCT OR THE BREACH OR DELAY IN PERFORMANCE OF THE WARRANTY.

WARRANTY IS NOT VALID UNLESS WARRANTY CARD IS RETURNED

No part of this publication maybe translated, stored in an electronic retrieval system, reproduced, or partially or totally adapted by any means (including microfilm and Photostats) without prior permission. Copyright © 2011 RANGER All rights reserved. Dell, Canon, Microsoft, Windows 7, MS and MS-DOS are registered trademarks. Windows and the Windows logo are trademarks of Microsoft Corporation. IBM is a registered trademark of IBM Corporation.

BEFORE YOU BEGIN

NOTIFY THE CARRIER AT ONCE if any hidden loss or damage is discovered after receipt and request the carrier to make an inspection. If the carrier will not do so, prepare a signed statement to the effect that you have notified the carrier (on a specific date) and that the carrier has failed to comply with your request.

IT IS DIFFICULT TO COLLECT FOR LOSS OR DAMAGE AFTER YOU HAVE GIVEN CARRIER A CLEAR RECEIPT. Support claim with copies of the bill of lading, freight bill, invoice, and photographs, if available. BendPak's willingness to assist in helping you process your claim does not make BendPak responsible for collection of claims or replacement of lost or damaged materials.

IMPORTANT NOTICE

Do not attempt to install this machine if you have never been trained on basic automotive service equipment installation procedures. Never attempt to lift components without proper lifting tools such as a forklift or cranes. Stay clear of any moving parts that can fall and cause injury. These instructions must be followed to ensure proper installation and operation of your 3D Pro wheel aligner. Failure to comply with these instructions can result in serious bodily harm and void product warranty. Manufacturer will assume no liability for loss or damage of any kind, expressed or implied resulting from improper installation or use of this product.

PLEASE READ ENTIRE MANUAL PRIOR TO INSTALLATION

OWNER'S RESPONSIBILITY

To maintain equipment and user safety, the responsibility of the owner is to read and follow these instructions:

- ◆ Follow all installation and operation instructions.
- ◆ Make sure installation conforms to all applicable Local, State, and Federal Codes, Rules, and Regulations; such as State and Federal OSHA Regulations and Electrical Codes.
- ◆ Carefully check the equipment for correct initial function.
- ◆ Read and follow the safety instructions. Keep them readily available for machine operators.
- ◆ Make certain all operators are properly trained, know how to safely and correctly operate the unit, and are properly supervised.
- ◆ Allow unit operation only with all parts in place and operating safely.
- ◆ Carefully inspect the unit on a regular basis and perform all maintenance as required.
- ◆ Service and maintain the unit only with authorized or approved replacement parts.
- ◆ Keep all instructions permanently with the unit and all decals on the unit clean and visible.

DEFINITIONS OF HAZARD LEVELS

Identify the hazard levels used in this manual with the following definitions and signal words:



Watch for this symbol as it means: Immediate hazards which will result in severe personal injury or death.



Watch for this symbol as it means: Hazards or unsafe practices which could result in severe personal injury or death.



Watch for this symbol as it means: Hazards or unsafe practices which may result in minor personal injury, product or property damage.

INSTALLER / OPERATOR PROTECTIVE EQUIPMENT

Personal protective equipment helps makes installation and operation safer, however, it does not take the place of safe operating practices. Always wear durable work clothing during any installation and/or service activity. Shop aprons or shop coats may also be worn, however loose-fitting clothing should be avoided.

Tight-fitting leather gloves are recommended to protect the technician's hands when handling parts. Sturdy leather steel-toe work shoes and oil resistant soles should be used by all service personnel to help prevent injury during typical installation and operation activities.

Eye protection is essential during installation and operation activities. Safety glasses with side shields, goggles, or face shields are acceptable. Back belts provide support during lifting activities and are also helpful in providing worker protection. Consideration should also be given to the use of hearing protection if service activity is performed in an enclosed area, or if noise levels are high.





Do not attempt to operate this equipment if you have never been trained on basic alignment procedures / automotive lift operation.

IMPORTANT SAFETY INFORMATION

For your safety, read this manual thoroughly before operating the equipment. The Alignment System is intended for use by properly trained skilled automotive technicians. The safety messages presented in this section and throughout the manual are reminders to the operator to exercise extreme care when performing wheel alignments with this product.

It is assumed that, prior to using the Alignment System, the operator has a thorough understanding of the vehicle systems being serviced. In addition, it is assumed he has a thorough knowledge of the operation and safety features of the alignment rack or lift, and has the proper hand and power tools necessary to perform wheel alignments.

When using your garage equipment, basic safety precautions should always be followed, including:

1. Read all instructions and warning labels.
2. Care must be taken as burns can occur from touching hot parts.
3. Do not operate equipment with a damaged power cord or if the equipment has been dropped or damaged until it has been examined by a qualified serviceman.
4. Do not let cord hang over edge of table, bench or counter or come in contact with hot manifolds or moving fan blades.
5. If an extension cord is necessary, a cord with a current rating equal to or more than that of the equipment should be used. Cords rated for less than the equipment may overheat. Care should be taken to arrange the cord so that it will not be tripped over or pulled.
6. Always unplug equipment from electrical outlet when not in use. Never use the cord to pull the plug from the outlet. Grasp plug and pull to disconnect.
7. DO NOT TURN POWER OFF when the computer is running, this can destroy the software.
8. Let equipment cool completely before putting away. Loop cord loosely around equipment when storing.
9. To reduce the risk of fire, do not operate equipment in the vicinity of open containers of flammable liquids, such as gasoline.
10. Adequate ventilation should be provided when working on operating internal combustion engines.
11. Keep hair, loose clothing, fingers, and all parts of body away from moving parts.
12. To reduce the risk of electrical shock, do not use on wet surfaces or expose to rain.
13. Use only as described in this manual. Use only manufacturer's recommended attachments.
14. ALWAYS WEAR SAFETY GLASSES. Everyday eyeglasses only have impact resistant lenses, they are NOT safety glasses.

**IMPORTANT
SAVE THESE INSTRUCTIONS
DO NOT DISCARD**

IMPORTANT SAFETY INFORMATION

Risk of electrical shock



- ◆ Do not operate equipment with a damaged power cord or if the equipment has been dropped or damaged, until it has been examined by a qualified service person.
- ◆ If an extension cord is necessary, a cord with a current rating equal to or greater than that of the equipment should be used. Cords rated for less current than the equipment can overheat.
- ◆ Unplug equipment from electrical outlet when not in use. Never use the cord to pull the plug from the outlet. Grasp plug and pull to disconnect.
- ◆ Do not expose the equipment to rain. Do not use on wet surfaces.
- ◆ Plug unit into correct power supply.
- ◆ Do not remove or bypass grounding pin.
- ◆ Contact with high voltages can cause death or serious injury.

Risk of electrical shock. High voltages are present within the console unit



- ◆ There are no user serviceable items within the console other than the keyboard and printer.
- ◆ Service on the unit must be performed by qualified personnel.
- ◆ Do not open any part of the console other than noted areas.
- ◆ Turn power switch off, disconnect the batteries in all sensor heads and unplug the unit before servicing.
- ◆ Contact with high voltages can cause death or serious injury.

Risk of eye injury



- ◆ Debris, dirt, and fluids may drop from vehicle.
- ◆ Wear approved safety goggles when servicing.
- ◆ Knock off any loose debris.
- ◆ Clean surfaces as needed to avoid any materials from falling from vehicle.
- ◆ Debris, dirt, and fluids can cause serious eye injury.

Risk of crushing



- ◆ Vehicles may roll off alignment lift if not secured.
- ◆ Leave automatic transmission in park or manual transmission in gear unless equipment operation steps require vehicle in neutral.
- ◆ Apply parking brake unless equipment operation steps require wheel movement.
- ◆ Use wheel chocks whenever vehicle is positioned on the lift.
- ◆ Follow rack or lift manufacturer's safety recommendations when lifting a vehicle.
- ◆ Vehicles rolling off lifts can cause death or serious injury.

Risk of entanglement or crushing. There are moving parts on vehicle lifts during operation



- ◆ Keep all persons clear of lifts.
- ◆ Read lift manufacturer's operation instructions carefully.
- ◆ Follow lift manufacturer's safety recommendations.
- ◆ Contact with moving parts could cause injury.

IMPORTANT SAFETY INFORMATION

Risk of pinching or crushing body parts when jacking vehicles



- ◆ Keep hands and other body parts away from jacking surfaces.
- ◆ Do not use unapproved adapters (i.e. wooden blocks) when jacking a vehicle.
- ◆ Do not bypass any jack manufacturer's safety features.
- ◆ Read jack manufacturer's operation instructions carefully.
- ◆ Follow manufacturer's safety recommendations. Improperly used or maintained jacks can cause injury.

Risk of burns



- ◆ Do not touch hot exhaust systems, manifolds, engines, radiators, etc.
- ◆ Wear gloves whenever performing a service near hot components.
- ◆ Hot components can cause burns.

Risk of injury. Tools may break or slip if improperly used or maintained



- ◆ Use the correct tool for the task.
- ◆ Frequently inspect, clean, and lubricate (if recommended) all tools.
- ◆ Follow recommended procedures when performing vehicle services.
- ◆ Tools that break or slip can cause injury.

OWNER'S RESPONSIBILITY

To maintain machine and user safety, the responsibility of the owner is to read and follow these guidelines:

- Follow all installation instructions.
- Make sure installation conforms to all applicable Local, State, and Federal Codes, Rules, and Regulations; such as State and Federal OSHA Regulations and Electrical Codes.
- Carefully check the unit for correct initial function.
- Read and follow the safety instructions. Keep them readily available for machine operators.
- Make certain all operators are properly trained, know how to safely and correctly operate the unit, and are properly supervised.
- Allow unit operation only with all parts in place and operating safely.
- Carefully inspect the unit on a regular basis and perform all maintenance as required.
- Service and maintain the unit only with authorized or approved replacement parts.
- Keep all instructions permanently with the unit and all decals on the unit clean and visible.

Installation Location

Choose a location that is in compliance with current work place safety regulations. The working area should provide the operator with enough space to install a four post lift or scissor lift and has easy access to drive a car on it. The place selected should be well lit, easy to clean and should be away from oil, grease, water, etc. Avoid areas where bystanders and customers may be present.

Proper unit installation is necessary for safe use and efficient operation. Proper installation also helps protect the unit from damage and makes service easier. Always keep this manual with the unit.

Installation Instructions

Appropriate procedures must be employed for effective assembly of your new Target 3D PRO wheel aligner system. Please refer to Installation Manual.

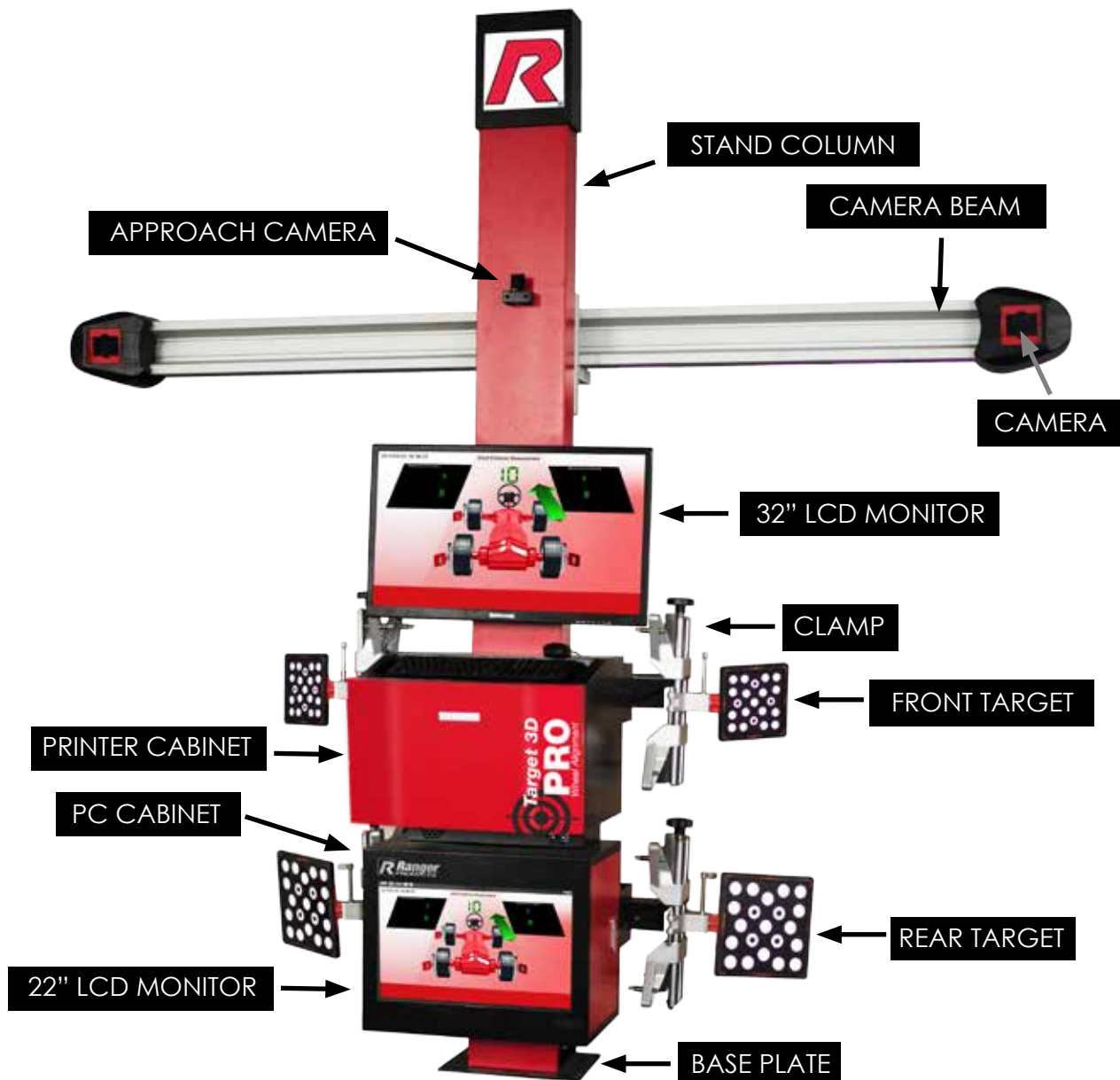

SYSTEM REQUIREMENTS

This equipment uses a 3D software, 64 bit program which can be installed on Windows 7 or Windows 8 Operating Systems.

TECHNICAL PARAMETERS

Power Supply: 110V - 240V

Frequency: 50/60HZ

Working Temperature: +5°C...+40°C (41°F...104°F)

Item	Precision / Accuracy	Range
Total Toe (Front and Rear Wheels)	±2'	±2°
Individual Toe	±2'	±2°
Camber	±2'	±3°
Wheel offset (Front Axle)	±2'	±2°
Thrust Line	±2'	±2°
Caster	±4'	±18°
King Pin	±4'	±18°
Toe out on turns	±4'	±20°
Adjustment range of Caster	±4'	±7°
Wheel offset (Rear Axle)	±2'	±2°
Wheelbase offset	±3'	±2°
Tread offset (left and right)	±2'	±2°
Axle offset	±3'	±2°

LIFT REQUIREMENTS

It is required that the wheel alignment operation area should have enough space to install a one unit four post lift or scissor lift and plenty of room for the car to drive on easily.

ALIGNMENT ANGLES

When vehicle wheel alignment is considered, there are three main angles that should not be ignored. These are: **CASTER**, **CAMBER**, and **TOE**. While these are prevalent, you should not overlook the other angles, because they will provide you a method of troubleshooting when dealing with a vehicle's suspension.

In cases of a major change to a vehicle's suspension, for example due to repair, the alignment is typically performed doing Caster first, then Camber, followed by Toe. If major changes are made, all angles should be re-checked and verified after adjustments have been made.

CAMBER ANGLE

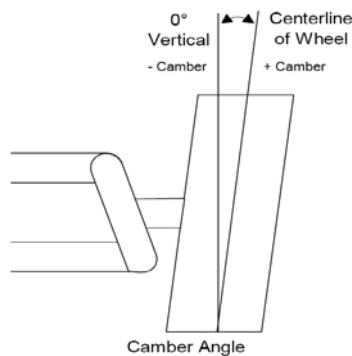

Camber is the angular measurement of the outward or inward tilt of the center-line of the wheel from true vertical at the top of the wheel. Positive camber is defined as an outward tilt from vertical, and negative camber would be an inward tilt. Camber is a tire wearing angle, and is usually adjustable. In cases where a factory adjustment is not available often there are shims or kits to make adjustments possible.

MEASUREMENT METHOD

This angle is read from an electrolytic vial (or on some older units, an electronic inclinometer) on each wheel unit.

WHAT CAMBER DOES

Camber helps to position the weight of the vehicle over the point where the tire contacts the road, thus placing the vehicle load on the inner wheel bearing.

NEGATIVE CAMBER

Negative Camber is used to ensure an even tire contact during cornering. Excessive negative camber can cause inside tire wear. The vehicle will pull to the side with the most positive camber if there is a difference in camber angle between sides.

POSITIVE CAMBER

Positive Camber is often used to induce understeer in some cars during hard cornering where most drivers cannot drive oversteer conditions that may be caused by negative camber. Excessive positive camber will cause outside tire wear. The vehicle will pull to the side with the most positive camber.

ADJUSTMENT METHODS

Shims, Cams, Slotted Frame, Strut Rotation, Wedges, Ball Joint Rotation, Offset Bearing Plates, Cam Bolts, Offset Bushings, Offset Ball Joints.

S.A.I. (STEERING ANGLE INCLINATION)

ALSO KNOWN AS:

K.P.I. (KING PIN INCLINATION)

B.J.I. (BALL JOINT INCLINATION)

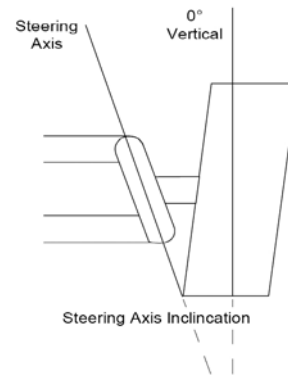

Steering Angle Inclination (S.A.I.) is the angular measurement of the inward tilt at the top from true vertical of the axis created by the front strut, ball joints, or kingpin of the vehicle's suspension. It is a non-adjustable angle. It may, however, change when any adjustment for camber is made. This will vary with different front suspension designs (MacPherson strut, short/long arm, I Beam, solid axle, etc).

MEASUREMENT METHOD

S.A.I. is calculated from readings taken from the Camber/Pitch level vial during the caster swing. S.A.I. does not contribute directly to tire wear.

WHAT SAI DOES

S.A.I. aids in weight distribution particularly on turns. It provides directional control stability and steering wheel return along with Caster. S.A.I. is always a positive angle, since by design a negative angle is not possible. S.A.I. may also be called B.J.I. (Ball Joint Inclination) or K.P.I. (King Pin Inclination).

INCLUDED ANGLE

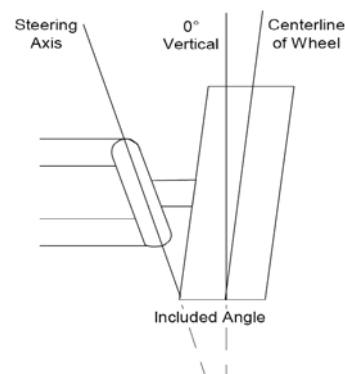

The Included Angle is the sum of Camber and S.A.I. It is actually this angle that is measured by the S.A.I. vial during the caster swing.

MEASUREMENT METHOD

S.A.I. is calculated by subtracting the measured camber from the included angle. See the examples shown below.

$$\text{CAMBER} = 2 \quad \text{INCLUDED ANGLE} = 3$$

$$3 - 2 = 1 \text{ S.A.I.}$$

$$\text{CAMBER} = -1 \quad \text{INCLUDED ANGLE} = 3$$

$$3 - (-1) = 4 \text{ S.A.I.}$$

Thus, the sum of the Camber and S.A.I. angles should equal the included angle. Camber is measured on the front wheels individually when each front wheel is swung to zero toe. This ensures the high accuracy and repeatability of the camber and S.A.I. readings.

WHAT IA DOES

I.A. is another method of SAI measurement and is often used to determine damage to the frame, sub-frame, K-member or suspension arms. I.A. is always a positive angle.

SCRUB RADIUS

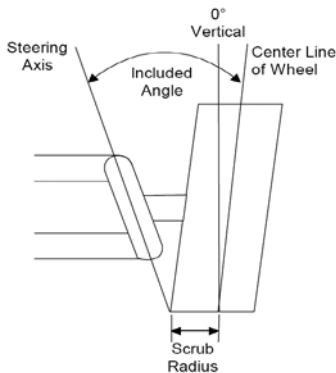

Scrub Radius is defined as the distance between the projected steering axis inclination (SAI) and the projected Centerline of the wheel at the point where the tire contacts the road surface. The point where the SAI angle intersects the road is where the force is applied to the tire. If there is a forward force of the vehicle (as it would be driving down the road), and the SAI was projected to the inside of the tire, the drag on the tire would tend to force the wheel outward. If the force were on the outside of the tire it would force it inward.

Scrub radius is a design determined specification, and not mechanically adjustable. However, if the scrub radius is incorrect, tire wear and hard steering could result.

POSITIVE SCRUB RADIUS

Positive scrub radius is defined as a steering axis inboard from the Centerline of the wheel (typical of Rear Wheel Drive vehicles), and negative scrub radius would be a steering axis outboard the Centerline of the wheel (typical of Front Wheel Drive Vehicles.)

The Scrub radius will change the effect that vehicle forces impose on the toe.

Positive Scrub Radius will tend to create a force moving the wheels outward on a rear drive vehicle. Negative Scrub radius creates a force that forces the wheels out on a front wheel drive vehicle while under power. This is found on front wheel drive vehicles using MacPherson Strut suspensions.

NEUTRAL SCRUB RADIUS

A Neutral or near zero scrub radius will reduce the effects of these forces. For this reason wheel selection can be critical particularly on a front wheel drive vehicle. The wrong wheel offset can create a different scrub angle and destroy the good handling of the vehicle and it cannot be compensated for in the alignment.

The suspension design for scrub radius can often be seen in the difference between front wheel drive and rear wheel drive. On front drive the wheels typically have their mounting surface toward the outside of the wheel making them more flat looking from the outside. Rear wheel drive suspension running a positive scrub radius will typically be dished.

CASTER ANGLE

Caster is the rearward or forward tilt of the steering axis from true vertical.

This angle is primarily used for directional stability while the vehicle is moving straight ahead.

Positive caster is defined as a rearward tilt at the top of the steering axis and a negative caster is a forward tilt.

The point where the caster axis intersects level ground is where the vehicle forces are projected. Most vehicles utilize some amount of positive caster. This angle does not normally contribute to tire wear when the vehicle is within the manufacturer's specifications.

MEASUREMENT METHOD

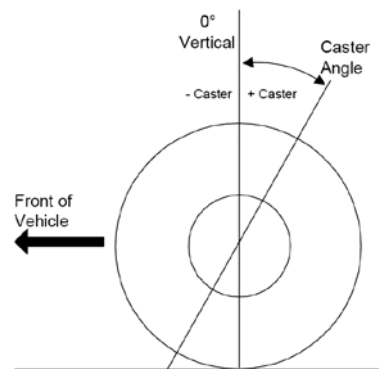

Caster is calculated by the change in Camber reading over a specific turning range of wheel from left to right. Caster can only be measured on the front wheels.

WHAT CASTER DOES

A positive caster will aid in steering wheel return to a straight ahead position. This is typically noticed following turns.

POSITIVE CASTER

If the angle is excessive (positive) steering will feel stiff going into turns typically on vehicles without power steering.

NEGATIVE CASTER

Negative caster will allow turning into corners easier while the vehicle is moving forward, however excessive negative caster will make the vehicle wander or cause it to be unstable at speed while driving straight ahead.

ADJUSTMENT METHOD

Strut Rod, Shims, Cams, Slotted Frame, Strut Rotation, Wedges, Ball Joint Rotation, Offset Ball Joints.

TOE

Toe is a design specification indicated by manufacturers to achieve a "running toe condition" which provides directional stability, low rolling resistance and optimum tire life.

MEASUREMENT METHOD

If dimension "B" is greater than dimension "A", the vehicle is defined to have "Toe In".

Toe can be measured both as an angle or by the difference between the "A" and "B" measurement. Though the method of measurement differs depending on regions and vehicle manufacturer's specifications, it is becoming increasingly common to measure toe as an angle.

WHAT TOE DOES

If "A" is greater than "B", the vehicle has negative toe or "Toe Out". On rear wheel drive vehicles, the front wheels are being pushed along the road, and normal road drag will act to separate the front edges of the front wheels as the play in the front end is taken up.

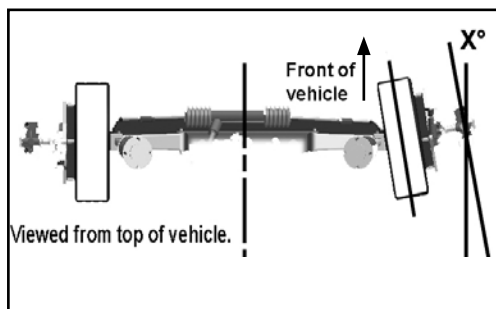

These rear wheel drive vehicles typically require some amount of toe in, such that when drag acts to separate the front wheels, the front ends track at zero toe. This assumes a typical positive scrub radius.

On most front wheel drive vehicles, the torque on the front wheels acts to pull the front edges of the front wheels together (when a positive scrub radius exists). In this situation, some toe out will allow the front wheels to track at zero toe. However, not all front wheel drive vehicles require toe out, and the manufacturer's specifications must always be checked before any adjustments are made. This is due to varying scrub angles which affect the toe dynamics while the vehicle is driving down the road.

EXCESSIVE TOE

Toe is a common tire wearing angle. Excessive toe either in or out will cause tire wear and unstable operation. When the toe is extreme the vehicle will typically go in the direction of the most loaded tire (or the one with the most traction), meaning that as the vehicle goes over bumps it will dart from one side to the other. This can also be due to bump steer which is a different condition. Bump Steer is caused when the toe angle changes as the vehicle suspension compresses expands.

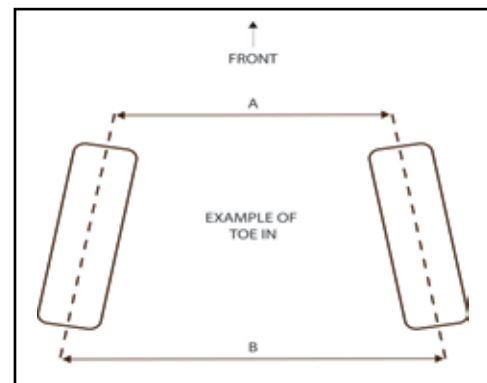

ADJUSTMENT METHOD

Almost all vehicles use some form of Tie Rod Adjuster.

When toe is measured it represents the difference between dimension "A" and "B". Dimension "A" is the distance from the extreme front edge (centerline) of the left tire to the extreme front edge of the right tire. Dimension "B" is the distance from the extreme rear edge (centerline) of the left tire to the extreme rear edge of the right tire. The toe present on the vehicle is then (B - A). Toe measurements are read as an angular measurement.



Preparation Before Alignment

Before starting wheel alignment and placing vehicle onto the lift, the following inspection should be done on the Approach Camera to make sure it has been activated.

1. Click “camera” icon located on the lower left side on the homepage.



2. Remove camera cover. If you forget to take off the cover you will not be able to see the vehicle approaching the ramp.



3. If view is out of focus, loosen the camera fixed screw with a Phillips screwdriver.



4. Use hand to turn the outside of lens slowly until you notice the image is clear. Turn clockwise or counter clockwise to adjust as necessary.

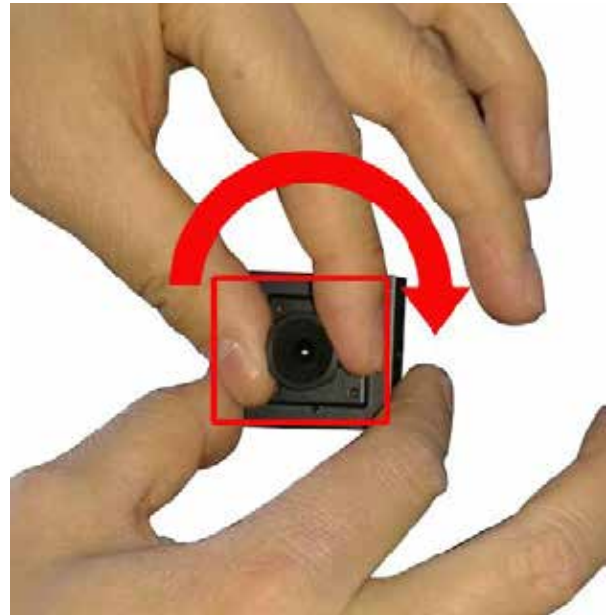

5. After the camera lens has been adjusted, drive the vehicle onto the lift, ensure that the front wheels are centered with the turntables. Apply the hand brake to make sure the car will not move. To prevent the turntables from turning, lock the turntables with their respective lock pins before driving the vehicle. You will be able to see the vehicle on the screen.



PREPARATION BEFORE ALIGNMENT

INSTALLING CLAMPS AND TARGETS

After all equipment has been set up, drive the vehicle onto the lift making sure the front wheels are centered with the turntables. Verify pins of turntables are locked. Apply vehicle brakes and place wheel chocks on the rear tires to ensure maximum safety. Install the wheel targets and clamps according to the pictures shown below.



CLAMPS



FRONT TARGET



REAR TARGET

FRONT AND REAR TARGETS INSTALLATION

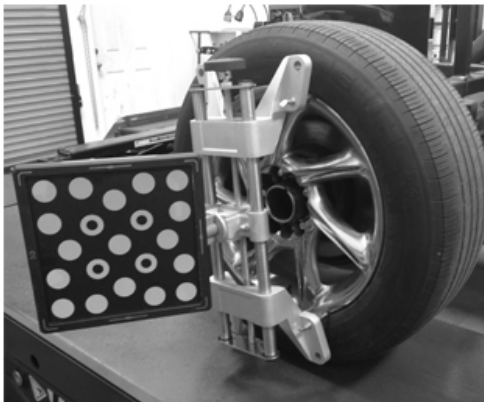

REAR TARGET INSTALLATION



FRONT TARGET INSTALLATION

Check clamps are installed on the wheel and turn the top knob to lock the wheel clamp. The claws of the wheel clamp should be fixed on the external edge of the rim. To install the targets, insert the locating pin of the targets in the groove of clamps and rotate the targets until they are tilted forward towards alignment cameras. Incline the targets about 5 degrees forward in relation to the vehicle. Make sure targets are locked on the clamps.

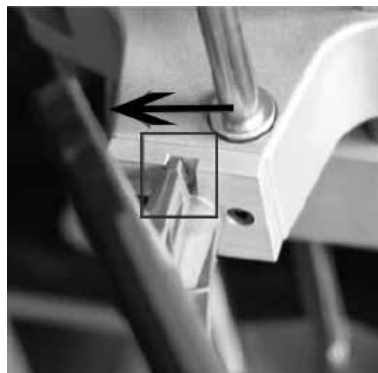

TARGET INCLINED
TOWARDS CAMERA

Cameras and Target Position

Make sure the cameras and all four targets are pointing in a relative position and within the camera view field, otherwise it will affect the measurement precision.

Automatic Lifting Camera Beam

The camera will trace the targets automatically and the camera beam will follow the targets to adjust the correct position; it can also be adjusted using the keyboard or mouse. (NO< NO< NO)

Target Status

Operator will be able to see on the screen if all targets are positioned in the correct camera view field by the colors displayed on the screen. Blue and green mean the targets are on the correct position and within the camera view field. Yellow means the targets are off the camera view field and out of the measurement range, the targets position should be adjusted. Solution: Move camera crossbeam until targets are correct color.

When installed correctly, the front targets will appear blue on the screen and the rear targets will show green. (See pictures below).

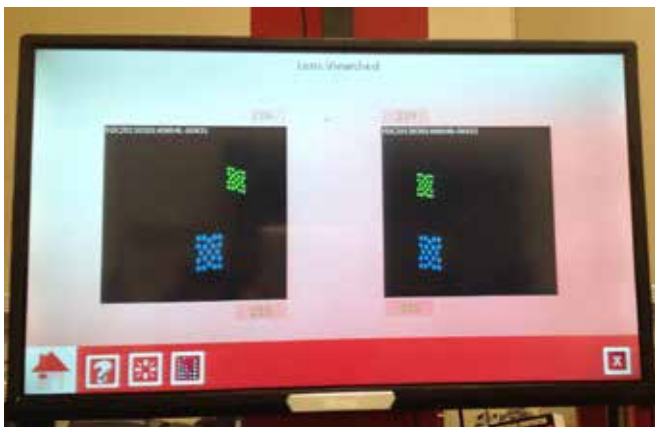
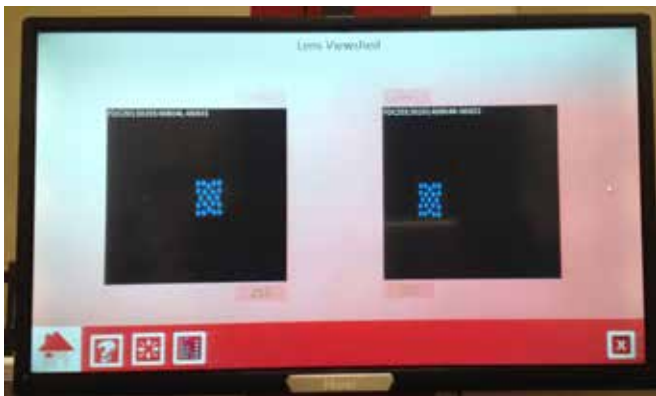

Adjusting Camera Beam

Fixed Camera Beam

Raise lift to proper height and position it on the locks. Unlock fixed knobs on the camera crossbeam, run the software program to target searching screen, adjust the camera beam position according to the targets image on the screen.



When you see the front targets are blue and the rear targets are green means the camera beam position is within tolerance.

Explaining Camera LED Indicators

The LED indicators on the right and left camera beam represent the four target status. Four LED indicators in red means the targets are stopped or immobile, if the LED indicator is red and flickering, this means the corresponding target is blocked (line of sight), not working correctly or not recognized by the system for any reason, as illustrated below.

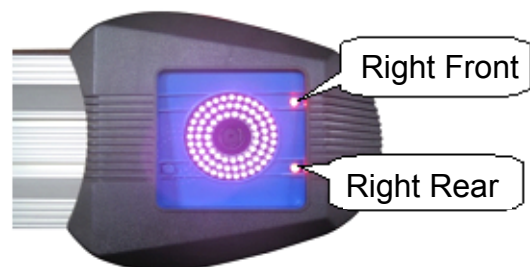
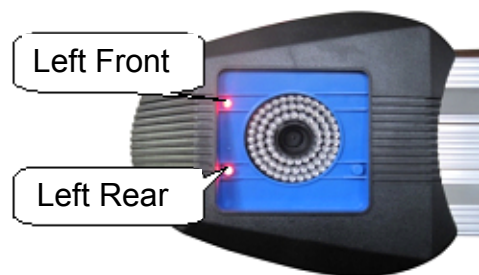

When the upper LED indicator on the left and right camera is red and the underneath LED indicator is flickering green it means push the vehicle towards the rear direction.



If both low LED indicators on the right and left camera are green and flickering, the steering wheel is in the middle position.



When the two LED indicators on the right camera are red, and the left camera shows a green flickering light on the top and a red light underneath, this means you should turn the steering wheel to the left.



When the underneath LED indicator on the left and right cameras is red and the upper LED indicator is green and flickering, the vehicle should be pushed towards the front direction.



If the LED indicators on both cameras are green and flickering on the top, this means the steering wheel is in the middle position.



If the two LED indicators on the left camera are red, and the upper LED indicator on the right camera is green and flickering and the lower indicator is red, you should turn the steering wheel to the right.



Before Performing Alignment

Drive vehicle unto lift. Use approach for safe placement of car on lift. To activate approach camera, remove camera lens cover, go to main menu page and clic camera icon located on the lower left corner of the screen.



APPROACH CAMERA

Make sure the vehicle has been checked for the following:

1. All wheel rims and tires should match and tires should be the same size.
2. Tread pattern should not be worn and all tires should have the correct manufacturer's specified air tire pressure.
3. Inspect and qualify condition of suspension components.
4. Gap between gear and steering lever (steering wheel play).
5. Wheel rim offset.
6. Vehicle is properly loaded side to side..
7. Shake vehicle to allow suspension return to rest position.
8. Make sure the pins of turntable and slide slip insert correctly. The pins can't take out until the vehicle drive on the turntable and slide slip.
9. Install the pedal locker correctly.

Installing Clamps

Install the clamps and targets on the wheel rim. Turn the center knob of the clamp to adjust its size to be suitable for rim. Make sure the 4 claws of the clamp stick to the wheel rim closely. Turn the knob of the clamp to fix it on the wheel tightly.



NOTE:
 TO PERFORM A FOUR WHEEL ALIGNMENT MEASUREMENT, TECHNICIAN SHOULD INSTALL ALL FOUR TARGETS FOLLOWING DIRECTIONS: (TWO FRONT TARGETS, TWO REAR TARGETS). TWO WHEEL ALIGNMENT MEASUREMENT: IT ONLY NEEDS TO INSTALL TWO FRONT TARGETS.

HOMEPAGE AND MENUS Homepage

Software program homepage is the beginning of measurement, there are two measurement ways: four wheel alignment, two wheel alignment. The operator can begin to measure after choosing new vehicle specification or after entering history customer information.

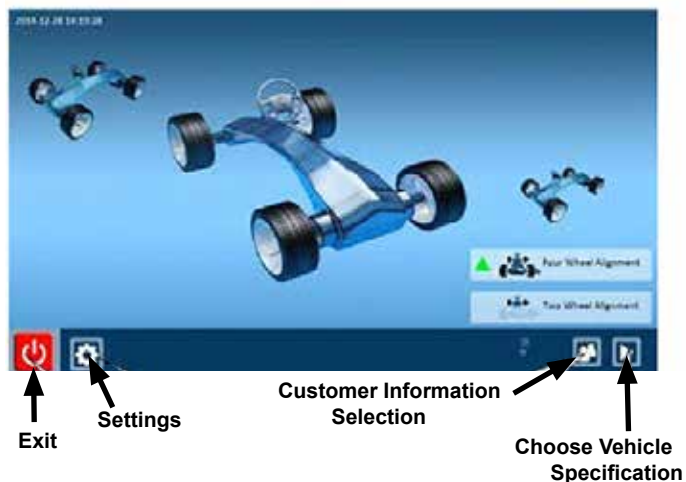

MENU EXPLANATION Vehicle Specification Screen Buttons

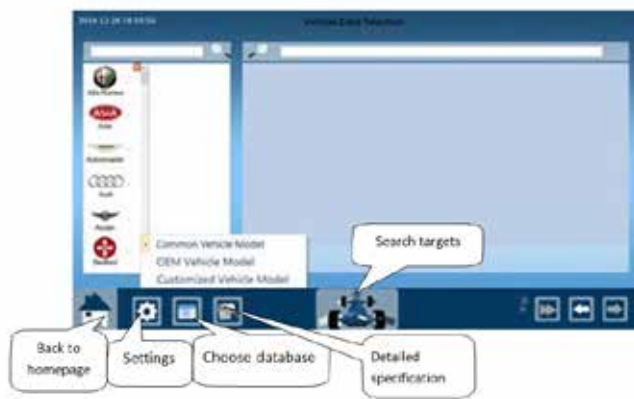

Search Targets Screen Buttons



4.2.3 Input customer information screen buttons

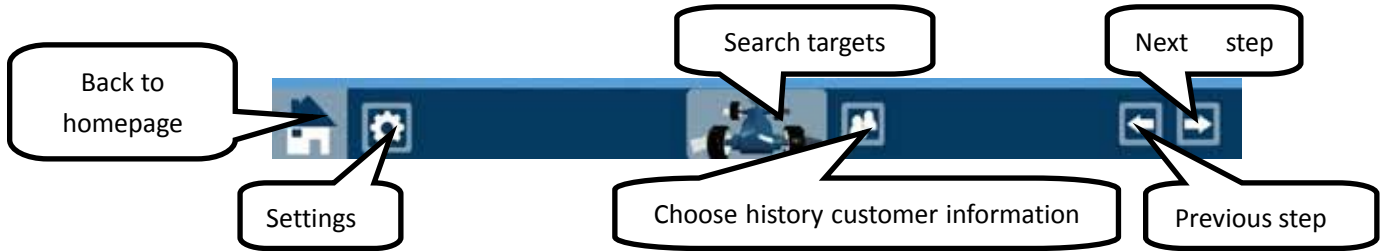

4.2.4 Preparation before measurement



4.2.5 Conventional measurement screen buttons



4.2.6 Report before adjustment screen buttons

2014-12-28 14:22:36

Report Before Adjustment

	Before Adjustment			Standard		
	Left		Right	Min. Value	Standard	Max. Value
Total Toe		1.80°		-0.23°	0.23°	0.70°
Toe	0.24°		1.56°	-0.12°	0.12°	0.35°
Camber	0.66°		3.00°	0.00°	0.50°	1.00°
Caster					6.00°	
KPI						
Toe-out on Turns						
Max. Steering Angle					-27.00°	
Set-back Angle	2mm					

	Left		Right	Min. Value	Standard	Max. Value
	Total Toe		1.34°			
Single Toe	1.36°		-0.02°			
Camber	-2.63°					
Thrust Angle		-0.69°				
Set-back Angle	2mm					

Detailed Values
 Additional Values

Back to homepage | Setting | Print | Add customer information | Search targets | Review measurement values | Previous step | Next step

4.2.7 Measurement results screen buttons

0.59° | 推力角 -0.23° | 0.14°

Close

Next page

4.2.8 Adjustment screen buttons

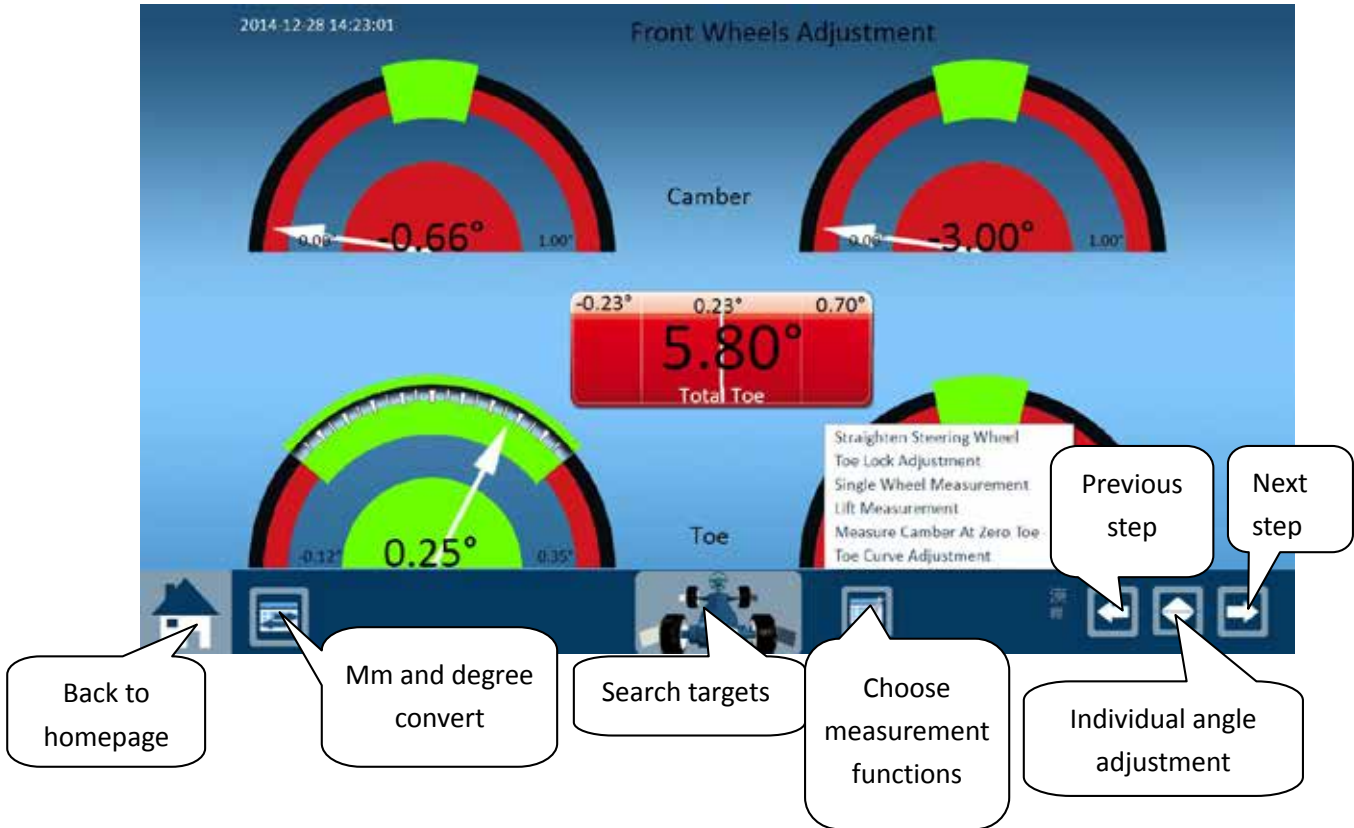

4.2.9 Straighten steering wheel of two wheel alignment measurement



4.3 Search targets screens buttons explanation

4.3.1 Search targets of fixed version

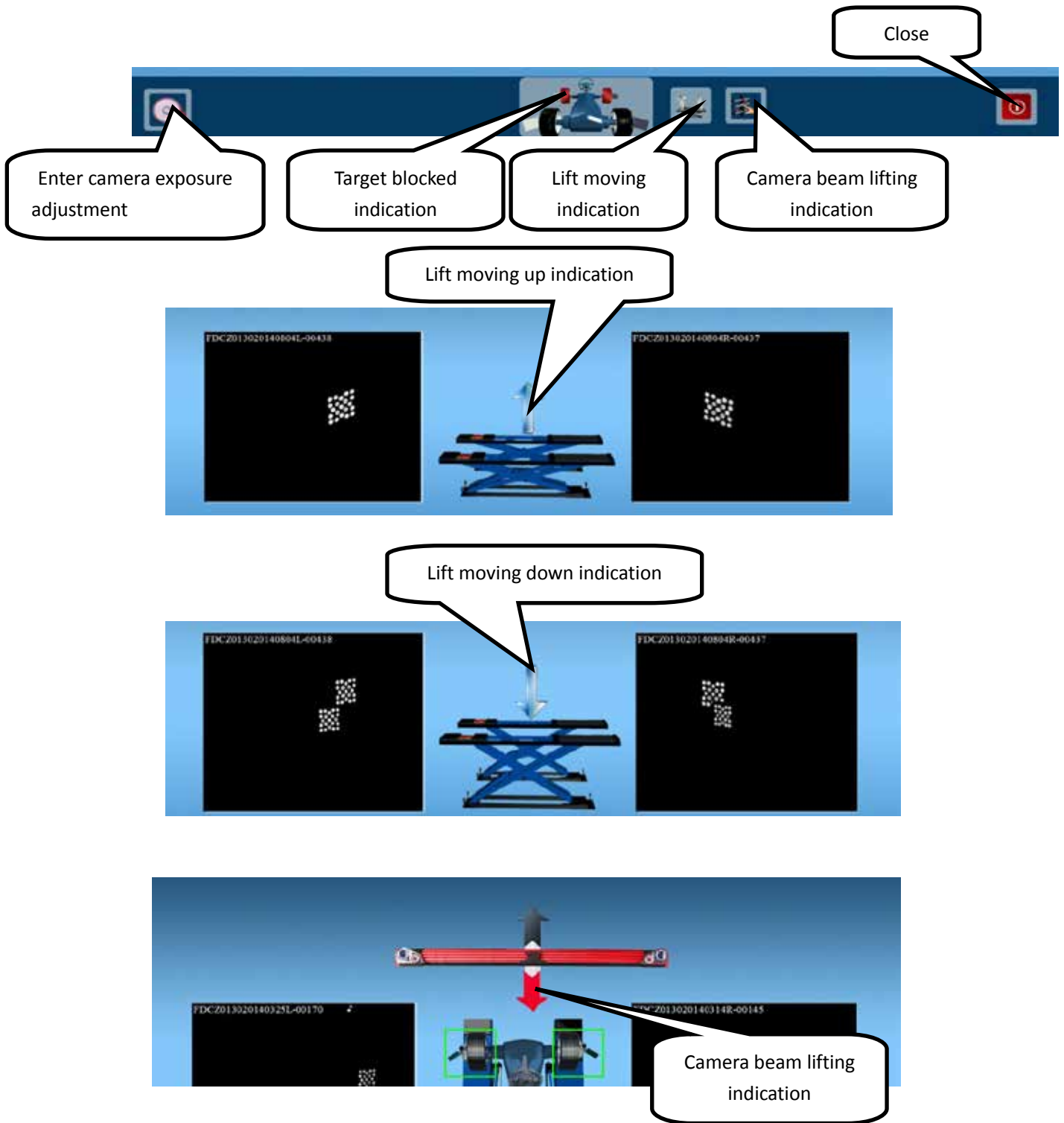

4.3.2.3 Lifting indication

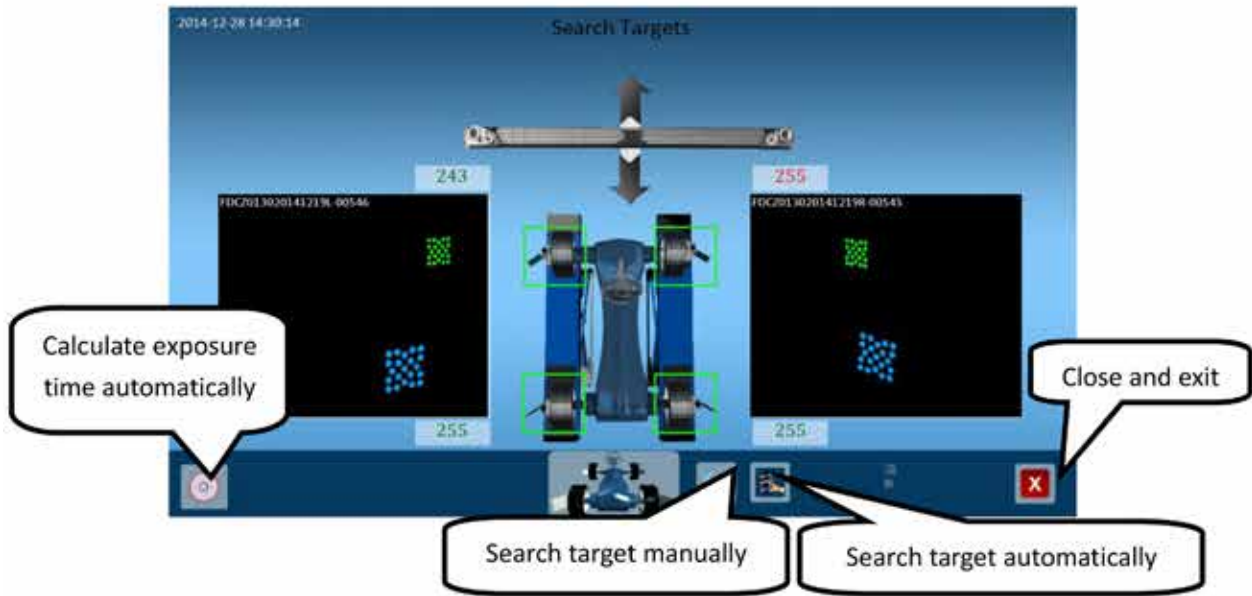

Camera beam moving up



Camera beam moving down



Search targets successfully

4.4 Target blocked indication

If the target is blocked during measurement, the wheel in the software program screen is in red color. See below photos for reference.

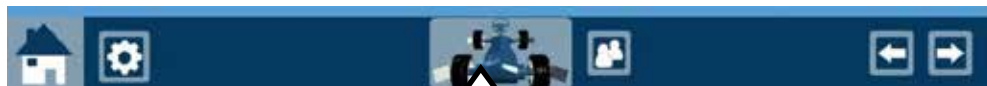

Target indication area



Targets are normal

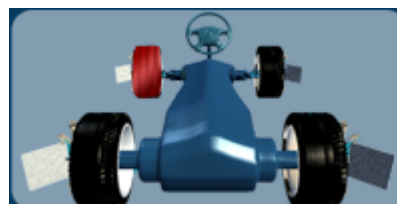

Front left target blocked



Front targets both blocked



Front and rear targets all blocked

4.5 Software Program Navigation Indication

The operator can press the navigation buttons on the software screen to control next step or previous step, also can press the “left” and “right” keys on the keyboard to control next step or previous step.

4.5.1 Software Screen Navigation Buttons



Previous Step: Back to previous screen.

Next Step: Continue to next screen

Fast Forward: The operator can skip “input customer information” screen after choosing vehicle specification and go to “preparation before measurement” screen directly.

After conventional measurement (push vehicle measurement), the operator can skip Caster measurement and go to straighten steering wheel screen directly.

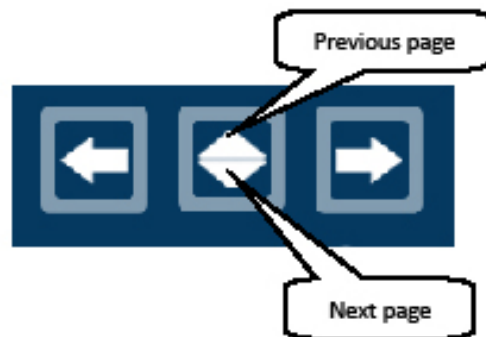

Previous Page: On adjustment screen, click previous page can enter all measurement values check screen.

Next Page: On adjustment screen, click next page can enter individual angle adjustment screen.

4.5.2 Keyboard Navigation

The operator also can press the left and right key on the keyboard to carry out previous step and next step functions. Press up and down key to carry out previous page and next page functions.

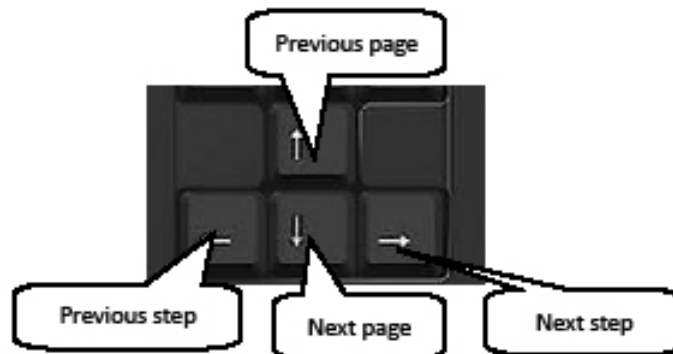

4.6 Search Targets

The operator can enter “search targets” screen to check the targets status (position and gray value) when install equipment, or before measurement or during measurement.

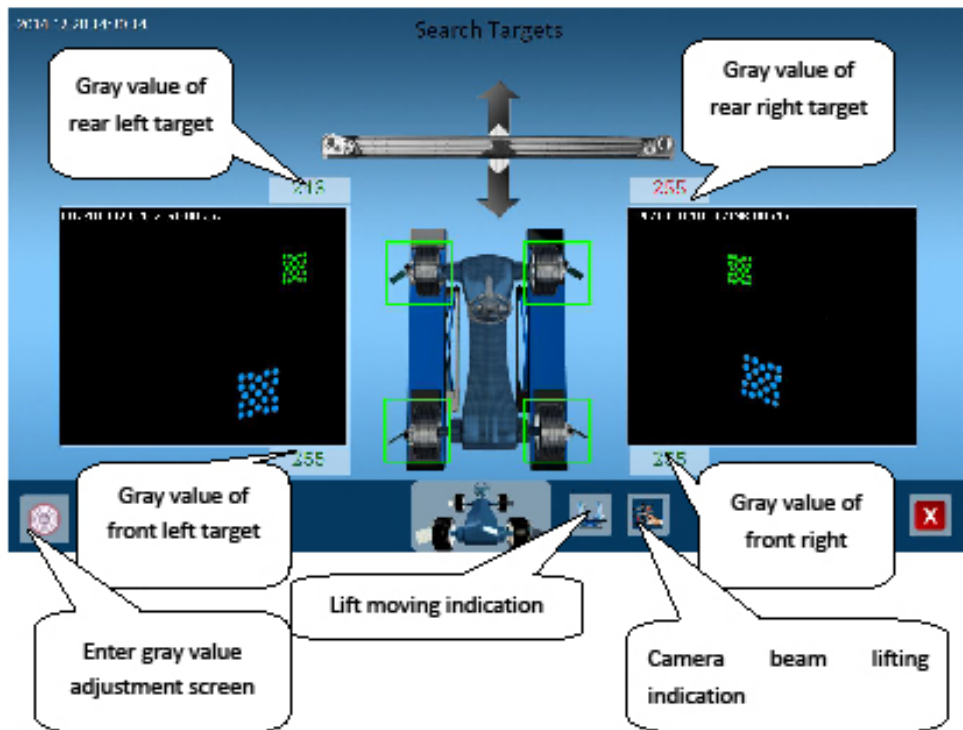

Search Targets Screen of Fixed Version 3D Alignment

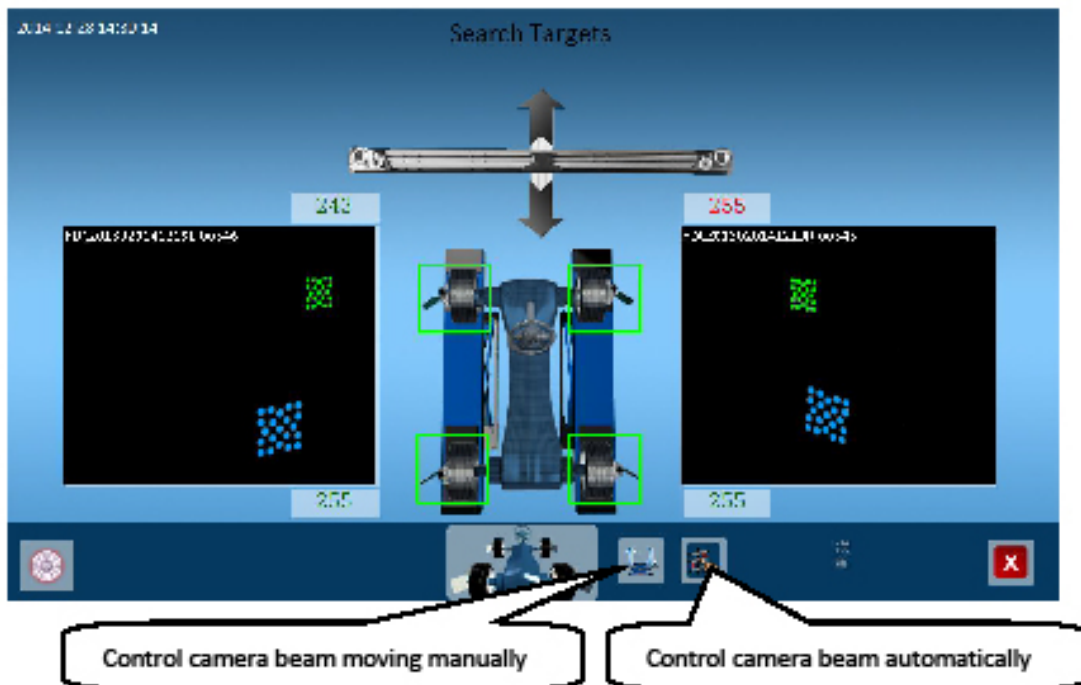

Search Targets Screen of Automatic Version 3D Alignment

4.6.1 Target gray values adjustment

Target gray values means the dots brightness of targets that shot by the camera. Gray values depend on LED light board exposure time and camera gain.

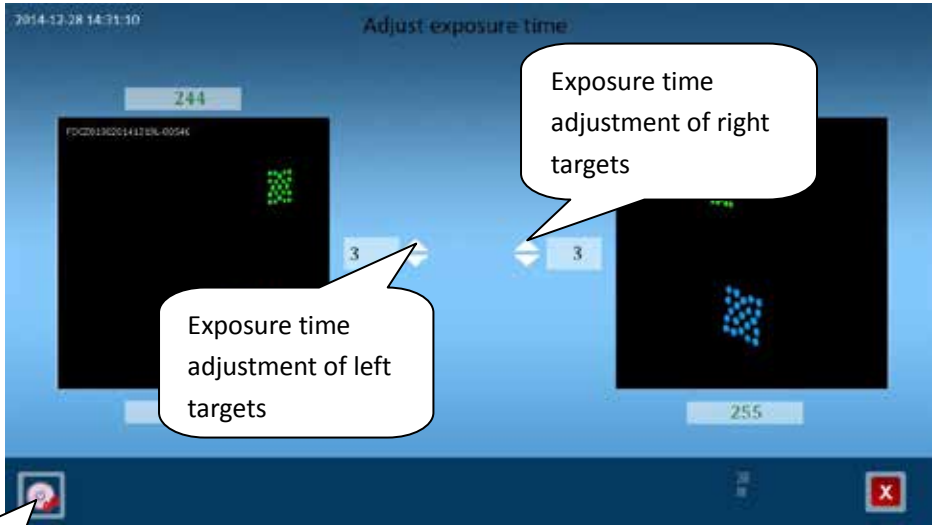

Exposure time adjustment of left targets

Exposure time adjustment of right targets

Calculate exposure time automatically

Gray values adjustment screen

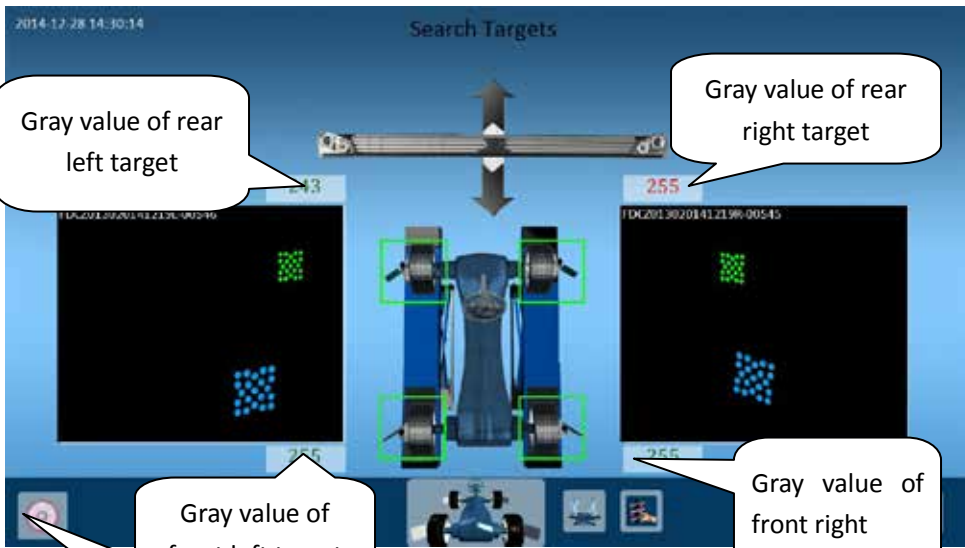

Gray value of rear left target

Gray value of rear right target

Gray value of front left target

Gray value of front right

Enter gray value adjustment screen

4.6.2 Gray values range of rear targets

1. The gray values range of rear targets is 210-255. If the rear target gray value is less than 210 when the operator run the cameras on “preparation before measurement” screen, the system will indicate to enter “gray value adjustment” screen to adjust values to the correct range. It will affect the measurement precision if the gray value less then 210.

2. The values on the screen is green when the rear targets gray value within the correct range, or it is red if the gray values out of correct range.

4.6.3 Gray values range of front targets

1. The gray values range of front targets is 210-255. If the front target gray value is less than 210 when the operator run the cameras on “preparation before measurement” screen, the system will indicate to enter “gray value adjustment” screen to adjust values to the correct range. It will affect the measurement precision if the gray value less then 210.

2. The values on the screen is green when the front targets gray value within the correct range, or it is red if the gray values out of correct range.

Chapter 5 Measurement Procedures

5.1 Choose measurement way



1. Operator can choose to do four wheel alignment or two wheel alignment on the homepage.
2. It must install four targets on the four wheels if choose four wheel alignment. It only need to install two targets on the front wheels if choose two wheel alignment.
3. It will display green triangle after been selected.
4. Click the measurement way will enter vehicle specification selection.
5. Operator can choose the new vehicle specification or choose the saved customer information to enter measurement procedure.

5.2 New measurement-choose vehicle specification



5.2.1 Choose vehicle specification

1. Operator can click “new measurement” button to enter “choose vehicle specification” screen. Then go on measurement.

2014-12-28 14:39:57

Vehicle Data Selection

Search by brand

Search by model

Choose database

Check detailed vehicle specification

Make	Model	Year	Country	Class	Price
Alfa Romeo	156	1997-2006	Italy	2.0L	634.91
Alfa Romeo	156	2002-2006	Italy	2.0L	932A2.000
Alfa Romeo	156	2003-2006	Italy	6.2L	616A.000
Alfa Romeo	156	2004-2007	Italy	2.4L	8410.000
Alfa Romeo	156	2004-2006	Italy	2.0L	324.99
Alfa Romeo	156	2007-2007	Italy	1.9L	927A5.000
Alfa Romeo	156 1.8	1997-2006	Italy	1.8L	634.91
Alfa Romeo	156 1.6 SPORT	1997-2006	Italy	1.6L	634.91
Alfa Romeo	156 1.8	1997-2006	Italy	1.8L	634.91
Alfa Romeo	156 1.6 SPORT	1997-2006	Italy	1.6L	634.91
Alfa Romeo	156 1.8D	1997-2006	Italy	1.8L	634.91
Alfa Romeo	156 1.9D SPORT	1997-2006	Italy	1.9L	634.91
Alfa Romeo	156 2.0	1997-2006	Italy	2.0L	634.91

Alfa Romeo 156

5.2.2 Detailed vehicle specification

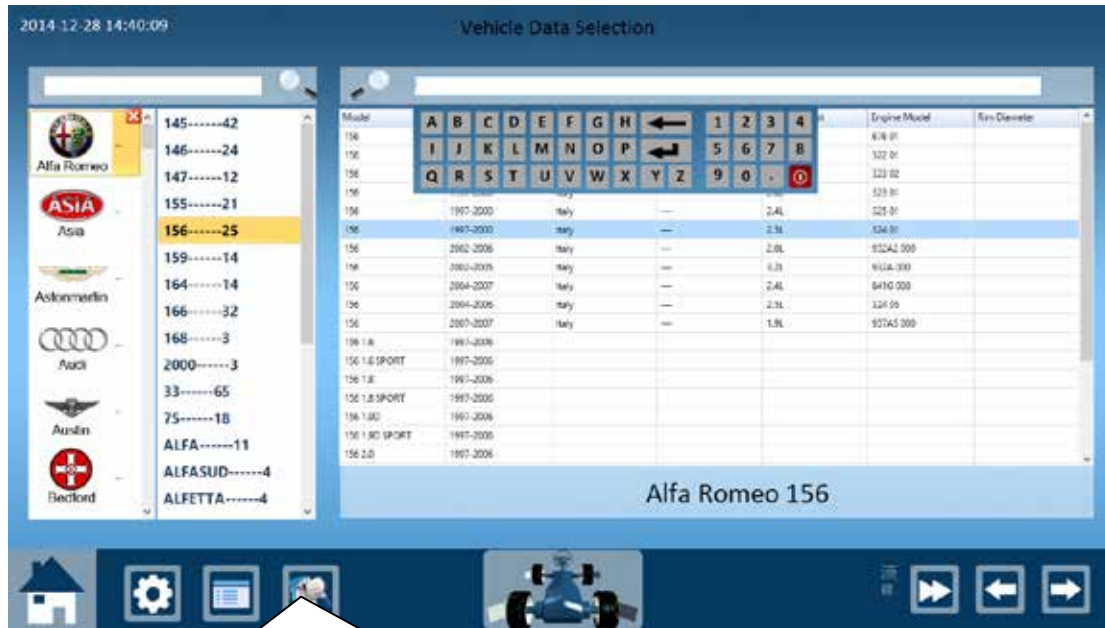

Check detailed vehicle specification information

For example, we choose Alfa Romeo 156, then we click to check detailed specification will see below photo.



5.2.3 Input customer information

1. Operator can enter measurement after inputting customer information, or also can skip input customer information to measurement function directly.
2. It must input "license plate number" when input customer information.
3. The customer information will be saved automatically after click next step. And will display on customer list area.
4. Operator also can click "history customer information" to choose saved history information.



5.3 History customer information

Operator can check the saved customer information and relevant adjustment reports after click “history customer information” button on homepage.



5.3.1 Choose history customer information

Click next step to enter “preparation before measurement” after choose saved customer information can check the history adjustment report.



5.3.2 Adjustment history reports

History Records									
	Before Adjustment			Standard Value			After Adjustment		
	Left		Right	Min.Value	Standard	Max.Value	Left		Right
									
Total Toe	5.48°			0.23°	0.57°	0.90°	5.73°		
Single Toe	3.79°		2.62°	0.12°	0.28°	0.45°	2.78°		2.60°
Camber	-6.20°		0.28°	1.33°	1.00°	-0.67°	-6.09°		0.29°
Caster	2.83°	3.33°	3.83°
KPI
Toe-out on Turns	0.00°		0.00°	0.00°		0.00°
Max. Steering Angd	0.00°	0.00°	0.00°	0.00°	0.00°	0.00°	0.00°
Set-back Angle	0mm		0mm	0mm		0mm
									
Total Toe	-1.15°			-0.43°	-0.10°	0.23°	-1.17°		
Single Toe	3.13°		-4.28°	-0.22°	-0.05°	0.12°	3.12°		-4.29°
Camber	-7.19°		3.00°	-1.50°	-1.00°	-0.50°	-7.19°		3.01°
Thrust Angle	-3.71°		3.71°	-3.70°		3.70°
Set-back Angle	0mm		0mm	0mm		0mm



Printout Button



close

5.4 Measurement ways

5.4.1 Preparation before measurement

1. Operator need to start cameras on “preparation before measurement” screen, also appear indication screen.
2. First, operator need to observe if the targets position and status are correct on “preparation before measurement” screen.
3. Second, observe if the targets exposure values is in green color, the software screen will indicate to adjust the exposure values if it is not green.
4. Third, prepare according to the three steps indication on the screen.

Install two targets on the front wheels if make two wheel alignment.

Install four targets on the four wheels if make four wheel alignment.

5. Fourth, choose the measurement way on the menu. The default measurement way is conventional push vehicle way.



5.4.2 Preparation- targets exposure values adjustment

1. If the targets exposure value on the “preparation before measurement” screen is out of standard range will affect the measurement precision. When the operator click next stop will appear the indication “camera exposure values is incorrect that will affect measurement precision, if transfer to adjust the exposure time?”



2. Enter “adjust exposure time” screen, adjust the exposure values of front and rear targets by adjust the exposure time of left and right cameras.

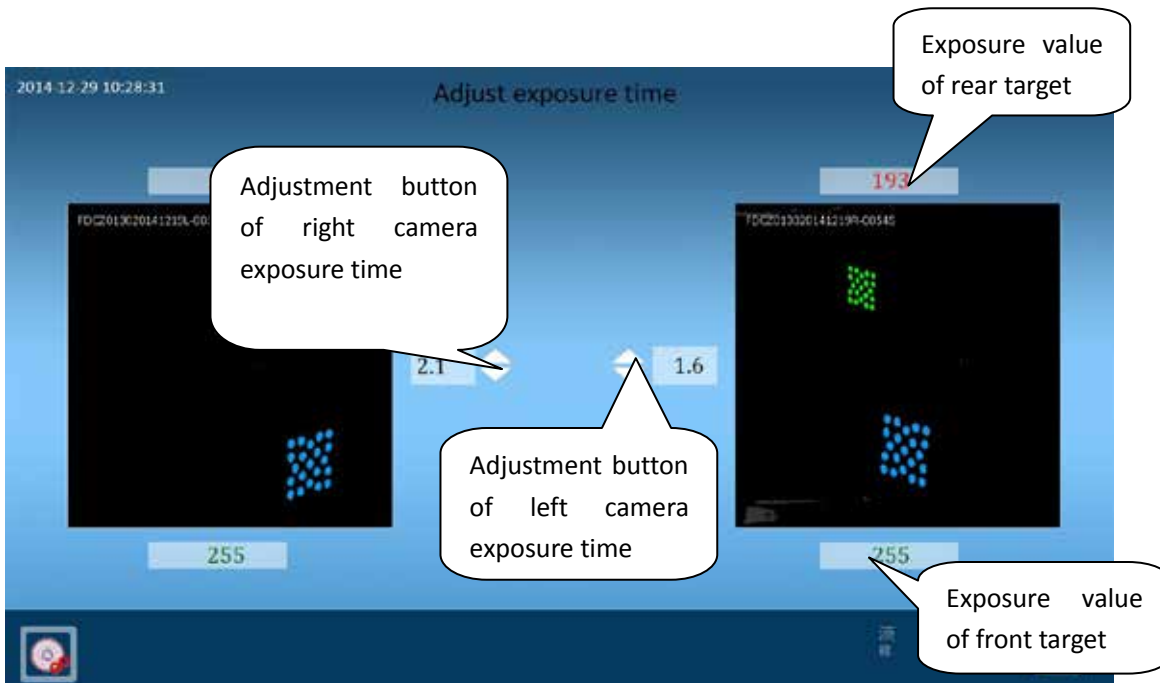

5.4.3 Super measurement

It must make sure the equipment make once TID after installation if choose super measurement. Make sure the 4 claws of clamp stick to the wheel rim very closely, or will affect measurement results. Otherwise, this measurement way used for small working place that doesn't have enough space to push the vehicle. We don't recommend customer always use this way, because the measurement precision maybe not as good as other measurement ways.

Operator choose "super measurement" item on "preparation before measurement" screen. Then enter "preparation before super measurement" screen, the operator must prepare according to the indications on the screen. See below photo for reference.



Click next step to begin super measurement.

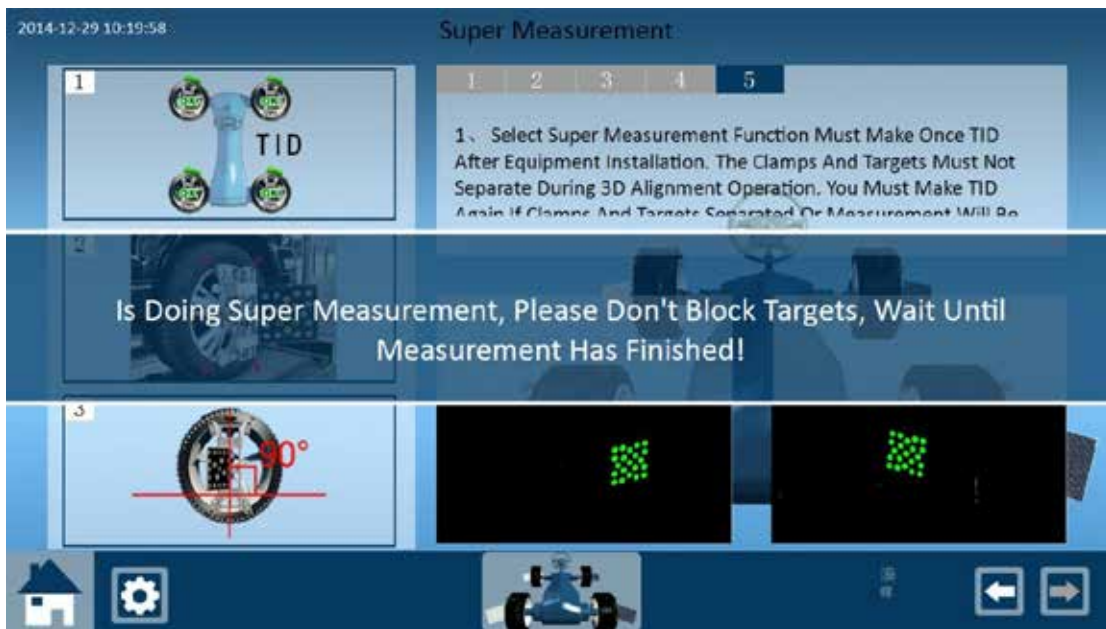

Measuring now!

After super measurement, enter "preparation before Caster measurement" screen.



5.4.4 Conventional measurement

Operator choose “conventional measurement” item on “preparation before measurement” screen. Then click next step to enter “conventional measurement” screen.

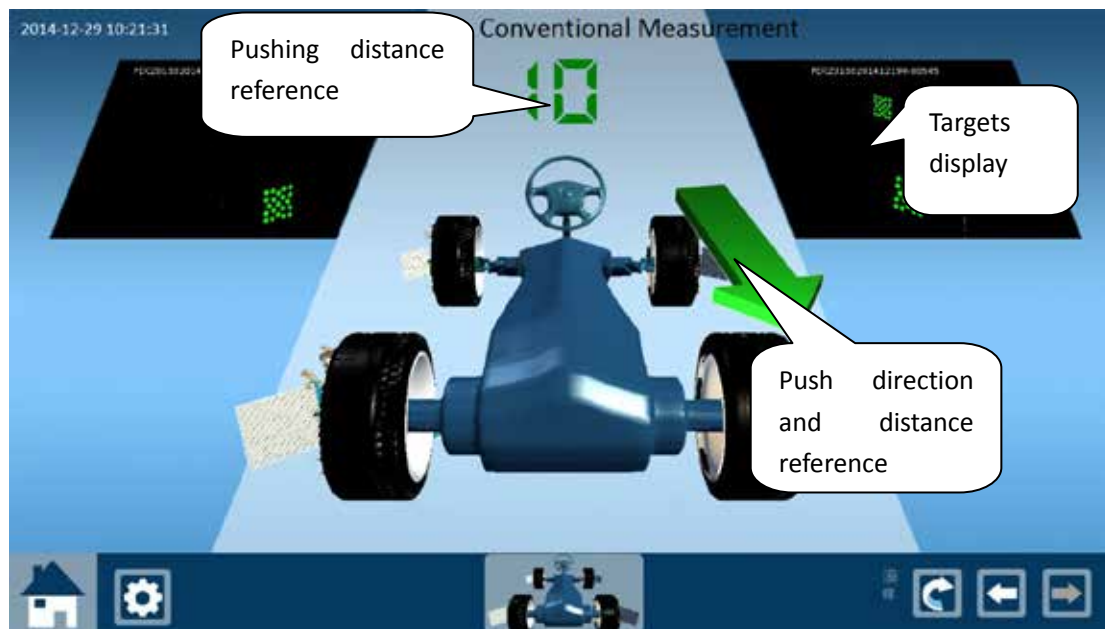
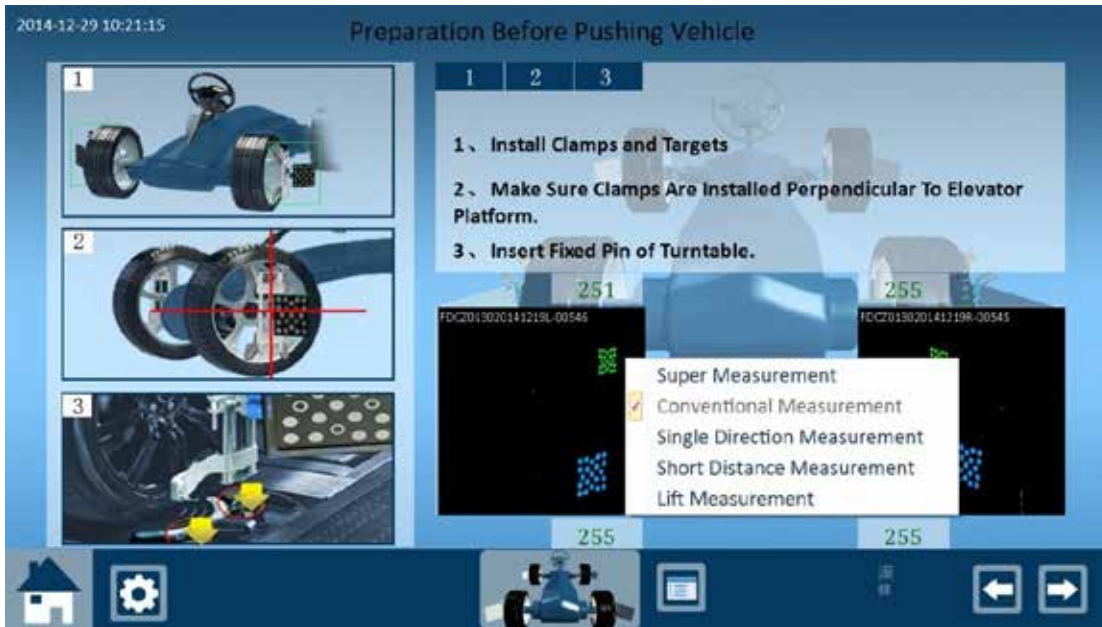

On “conventional measurement” screen, push the vehicle slowly to the tail direction according to indication on the screen till the number from

10 to 0 and appear STOP.

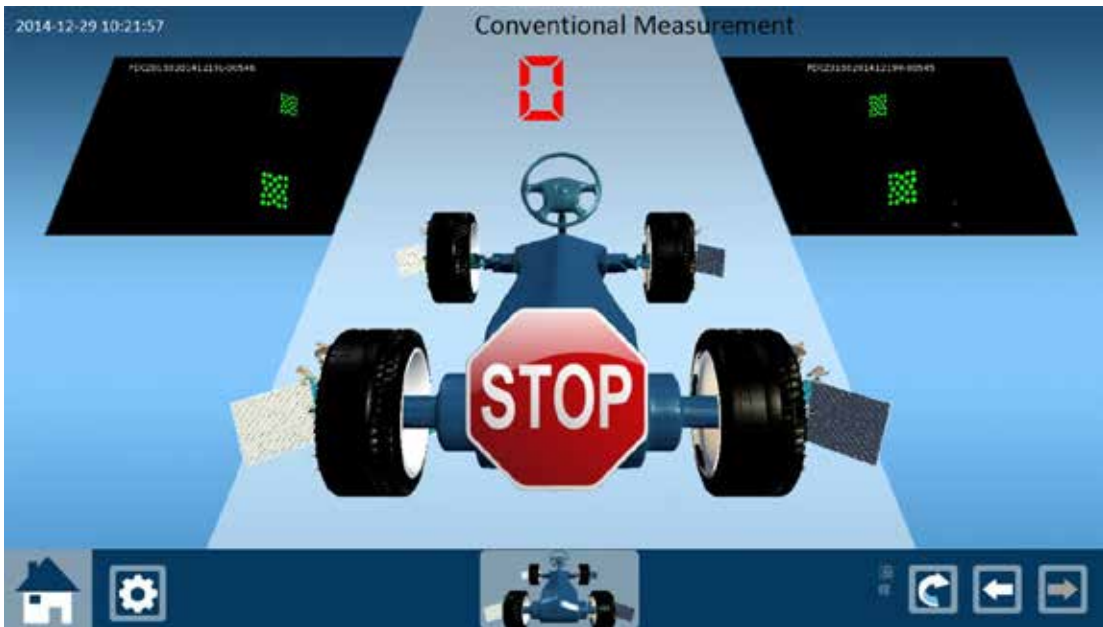

When “STOP” appear on the screen, it must stop pushing immediately and waiting for indication.



When the screen appears opposite arrow indication, push the vehicle to head direction slowly till the number from 10 to 0 and appear STOP.

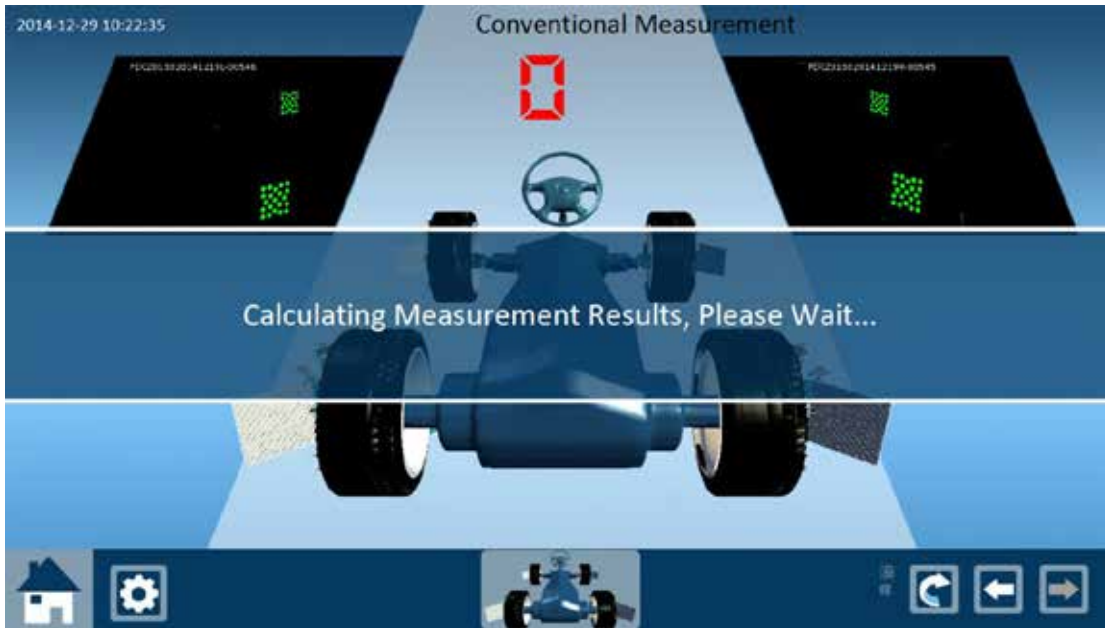

When “STOP” appear on the screen, it must stop pushing immediately and waiting for calculating results.

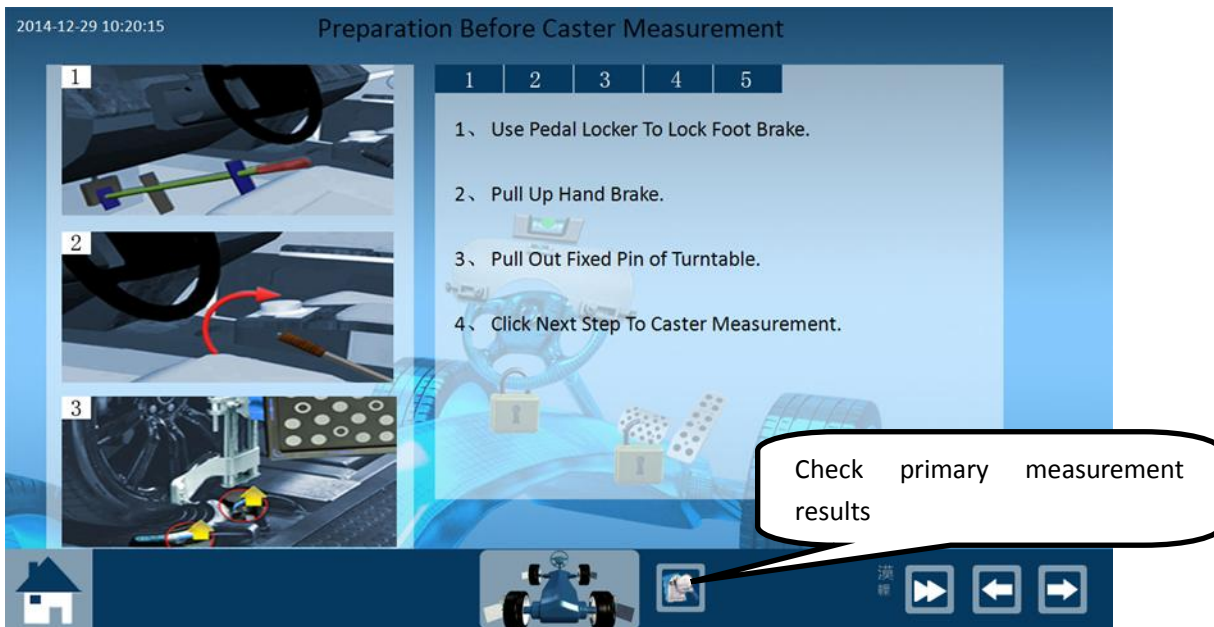

After conventional measurement, enter “preparation before Caster measurement” screen.



5.4.5 Single direction measurement

Operator choose “single direction measurement” item on “preparation before measurement” screen. Then click next step to enter “single direction measurement” screen.

The 'Preparation Before Pushing Vehicle' screen includes the following instructions:

- 1、 Install Clamps and Targets
- 2、 Make Sure Clamps Are Installed Perpendicular To Elevator Platform.
- 3、 Insert Fixed Pin of Turntable.

A menu is displayed with the following options:

- Super Measurement
- Conventional Measurement
- Single Direction Measurement
- Short Distance Measurement
- Lift Measurement

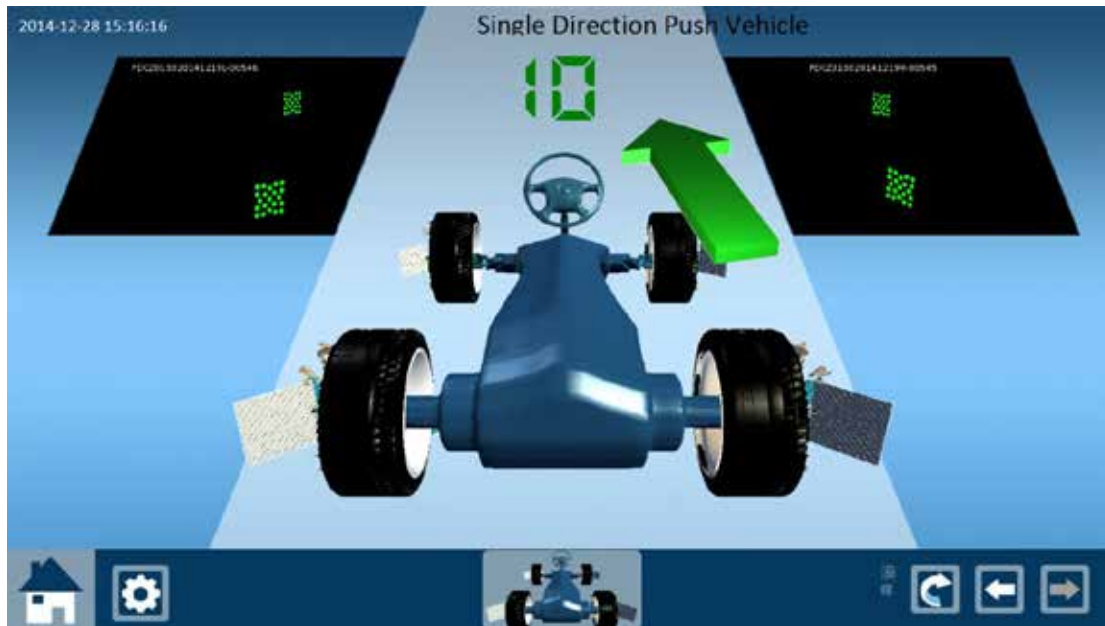

On “single direction measurement” screen, push the vehicle slowly to the arrow indication direction till the number from 10 to 0 and appear STOP.

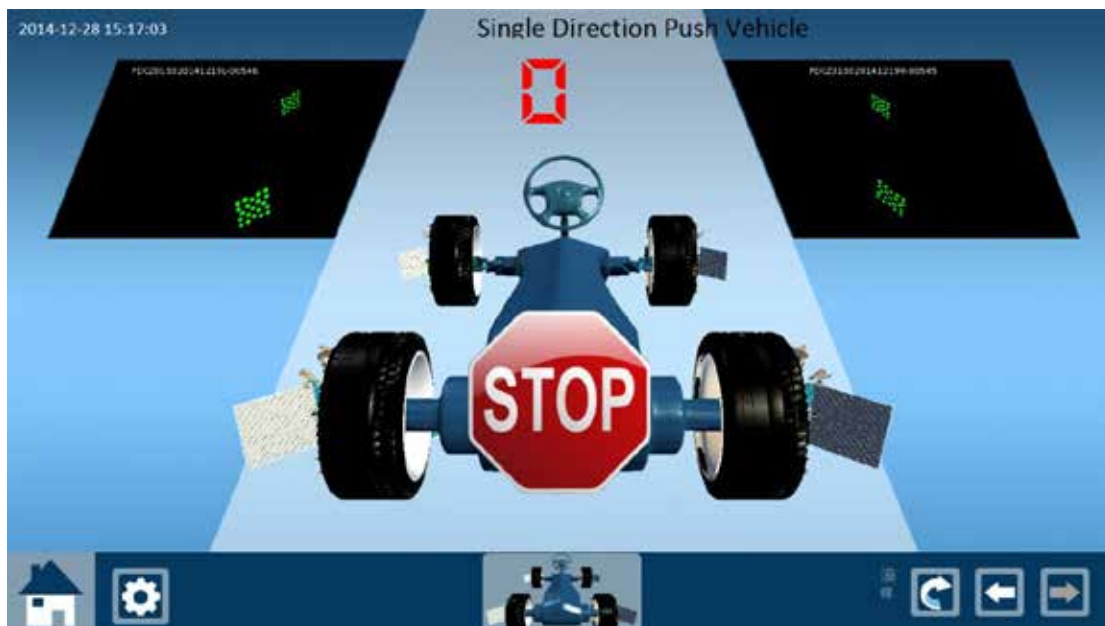

When “STOP” appear on the screen, it must stop pushing immediately and waiting for calculating results.

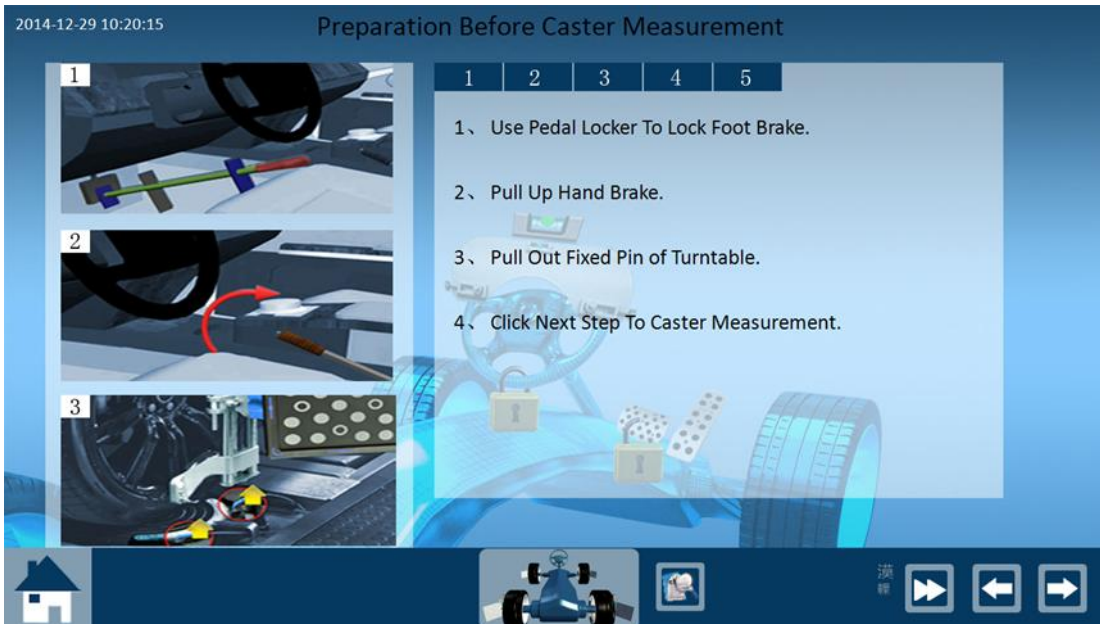

After single direction measurement, enter “preparation before Caster measurement” screen.

5.4.6 Short distance measurement

Operator choose “short distance measurement” item on “preparation before measurement” screen. Then click next step to enter “short distance measurement” screen.

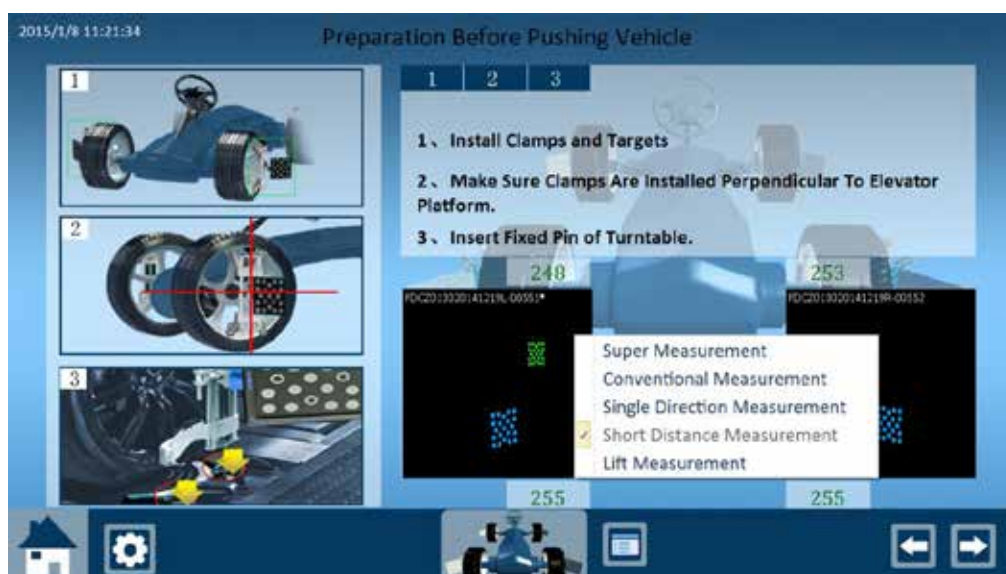

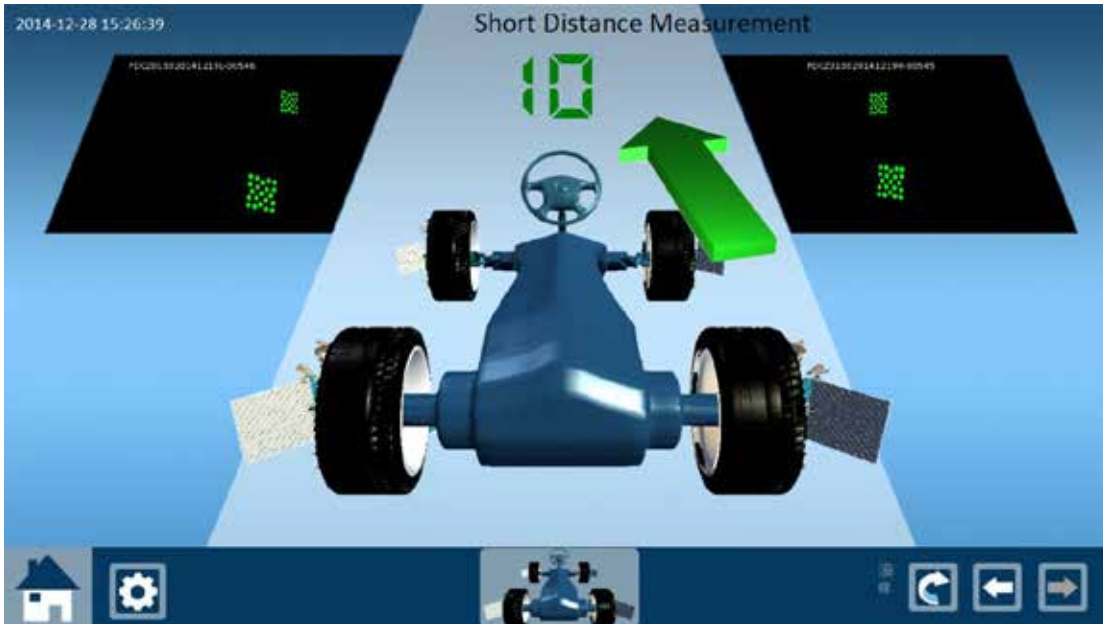

On “short distance measurement” screen, push the vehicle slowly to the head direction according to indication on the screen till the number from 10 to 0 and appear STOP.

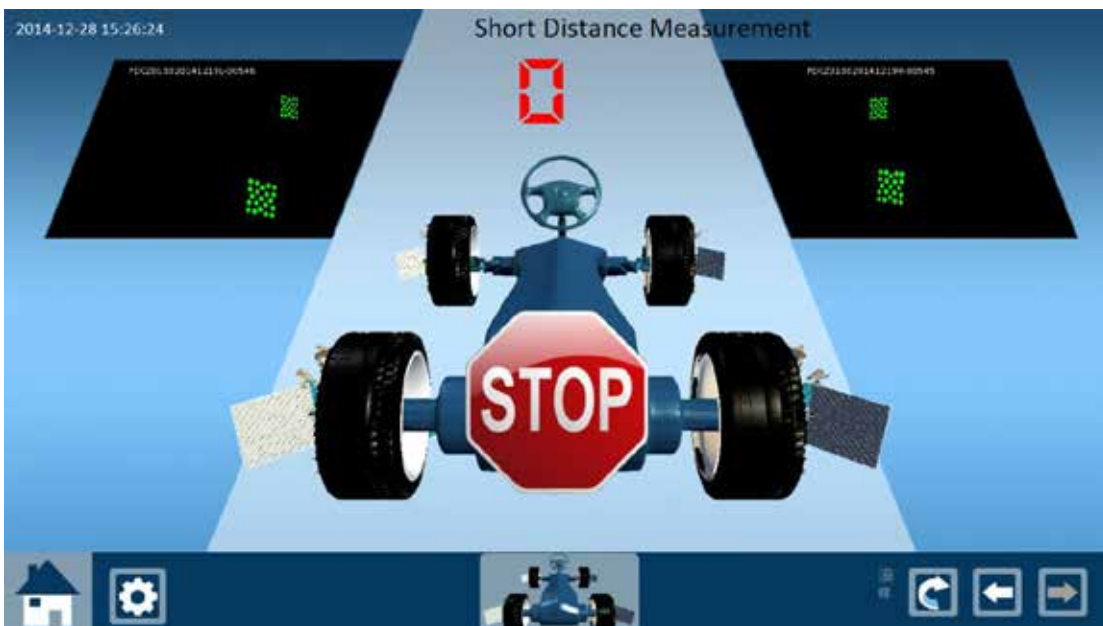

When “STOP” appear on the screen, it must stop pushing immediately and waiting for indication.

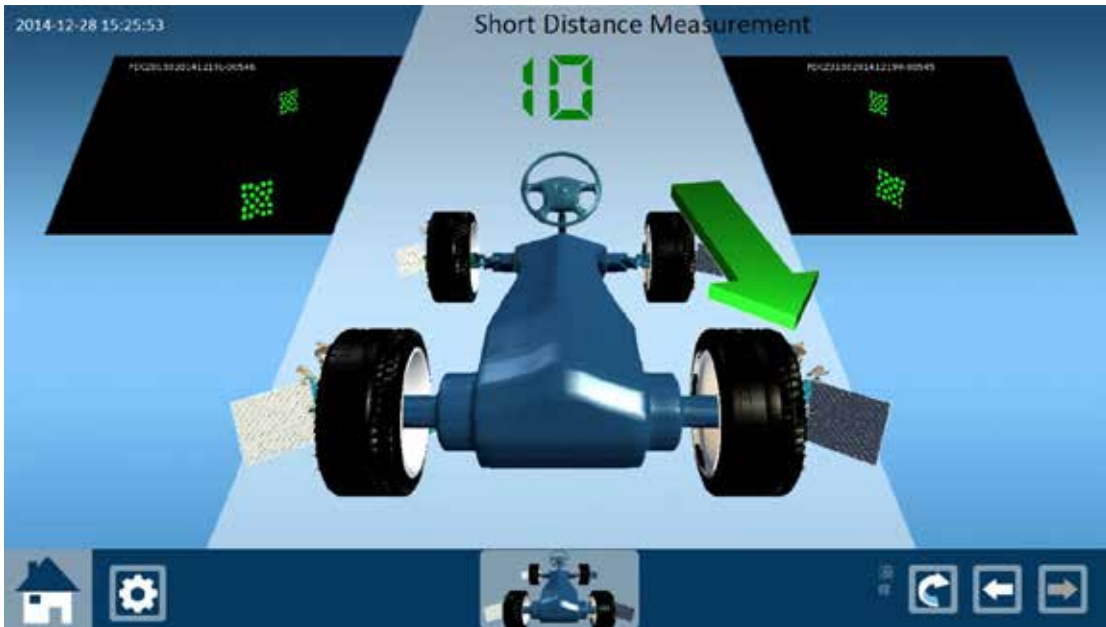

When the screen appear the arrow to opposite direction, push the vehicle slowly to the tail direction according to indication on the screen till the number from 10 to 0 and appear STOP.

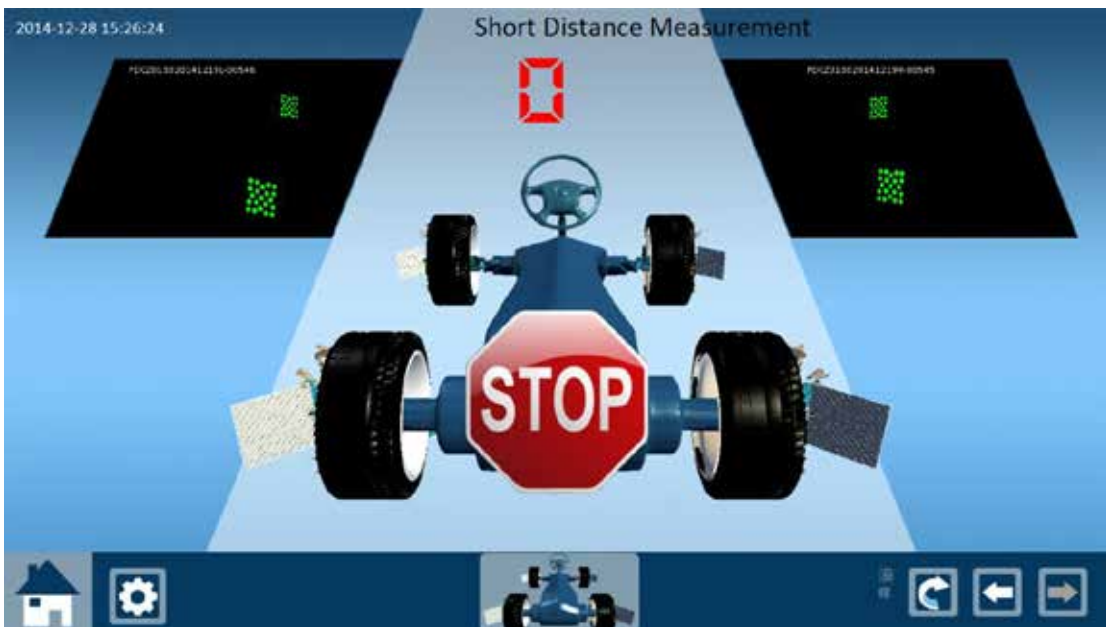

When "STOP" appear on the screen, it must stop pushing immediately and waiting for indication.

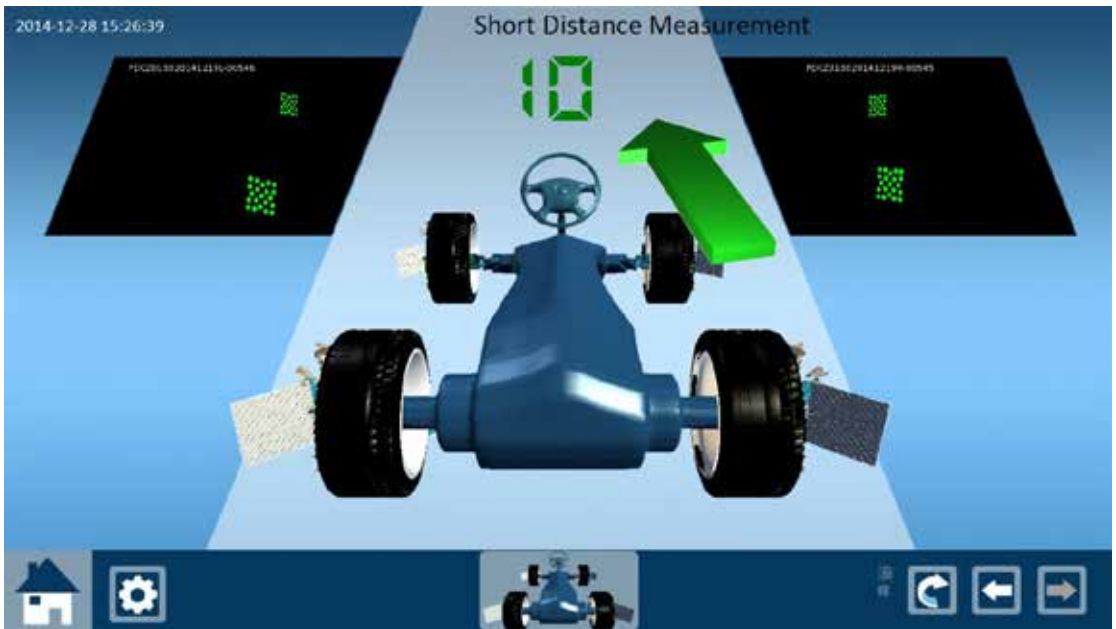

When the screen appears opposite arrow indication again, push the vehicle to head direction slowly till the number from 10 to 0 and appear STOP.

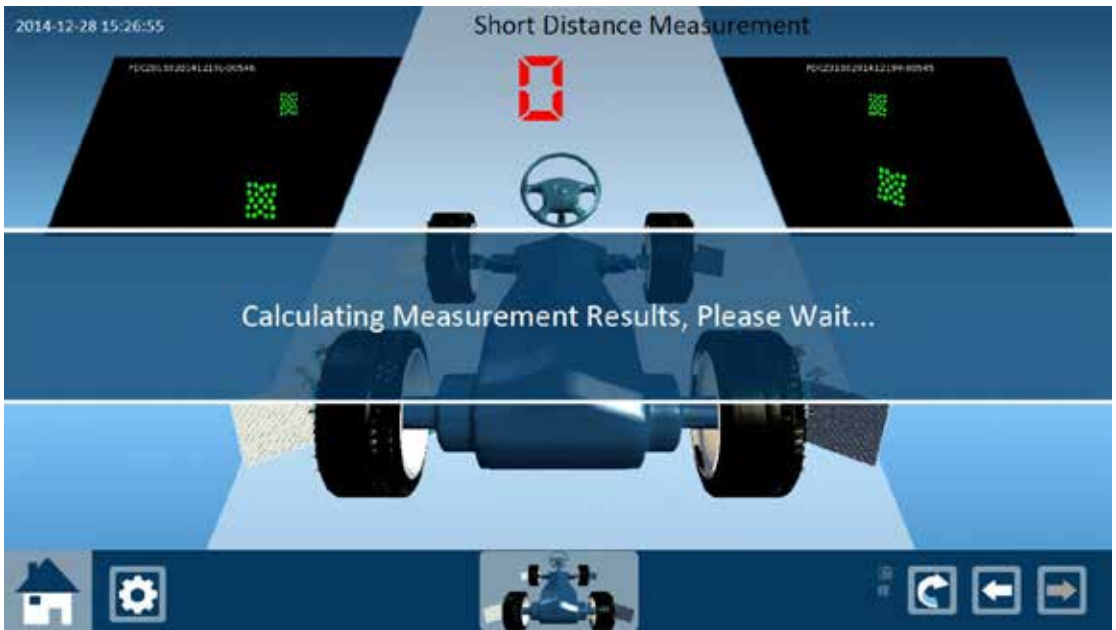

When "STOP" appear on the screen, it must stop pushing immediately and waiting for calculating results.



After short distance measurement, enter “preparation before Caster measurement” screen.

5.4.7 Lift measurement

Operator choose “lift measurement” item on “preparation before measurement” screen. Then click next step to enter “preparation before lift measurement” screen. The operator need to prepare according to the indications on the screen.



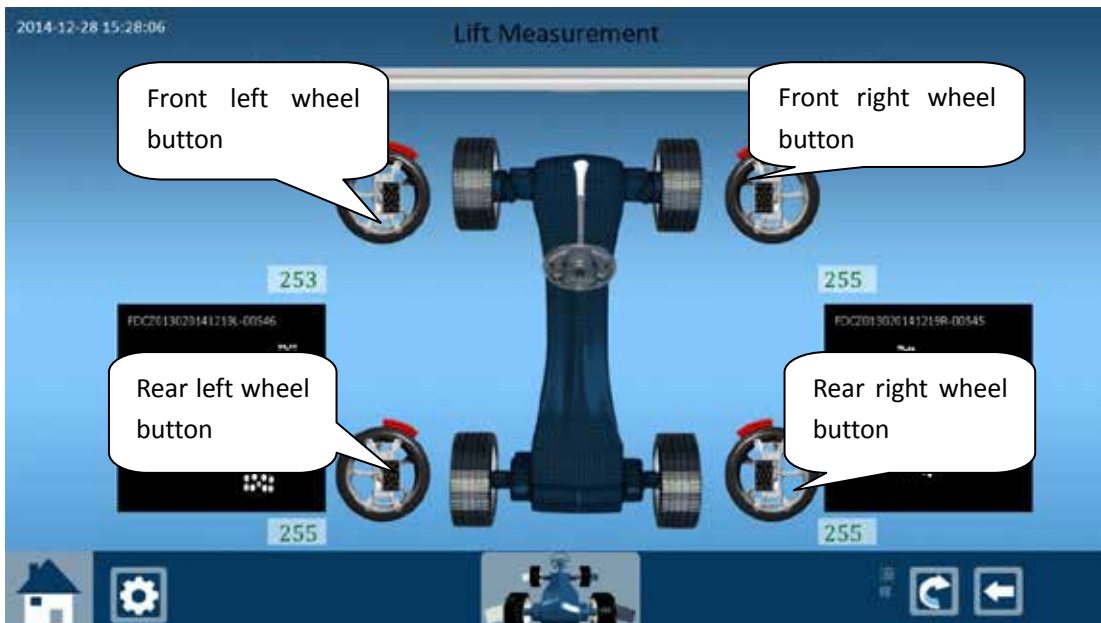
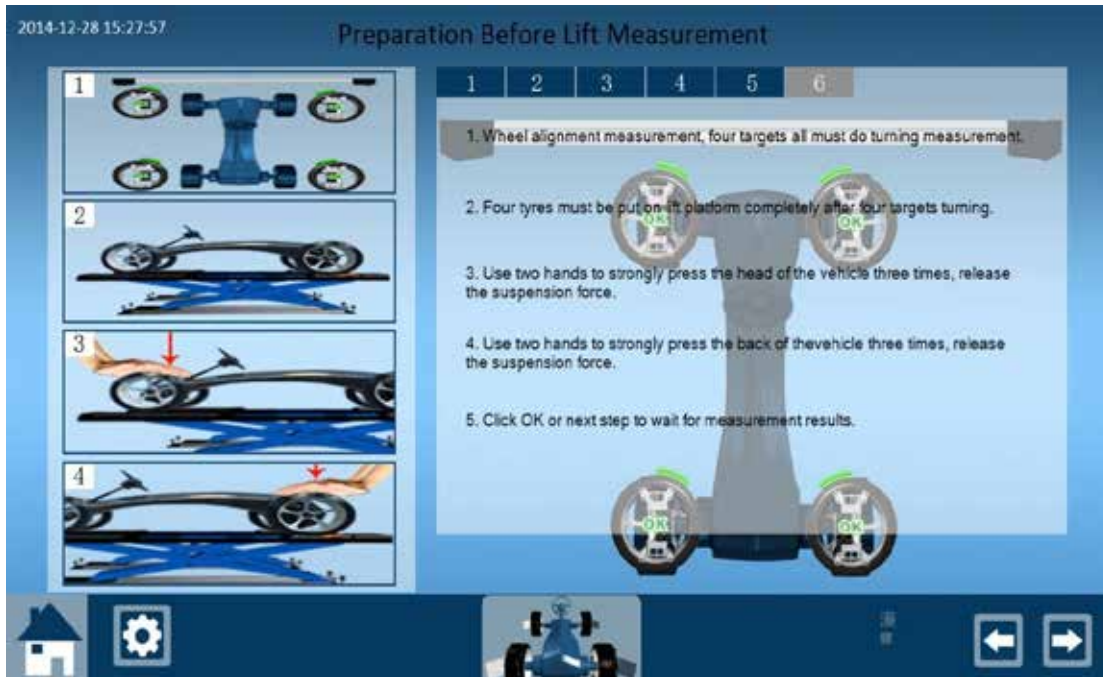

Operator click any wheel button can begin lift measurement, we choose to click front left wheel as example.



Click front left wheel button, the screen indicate to elevate front left wheel.

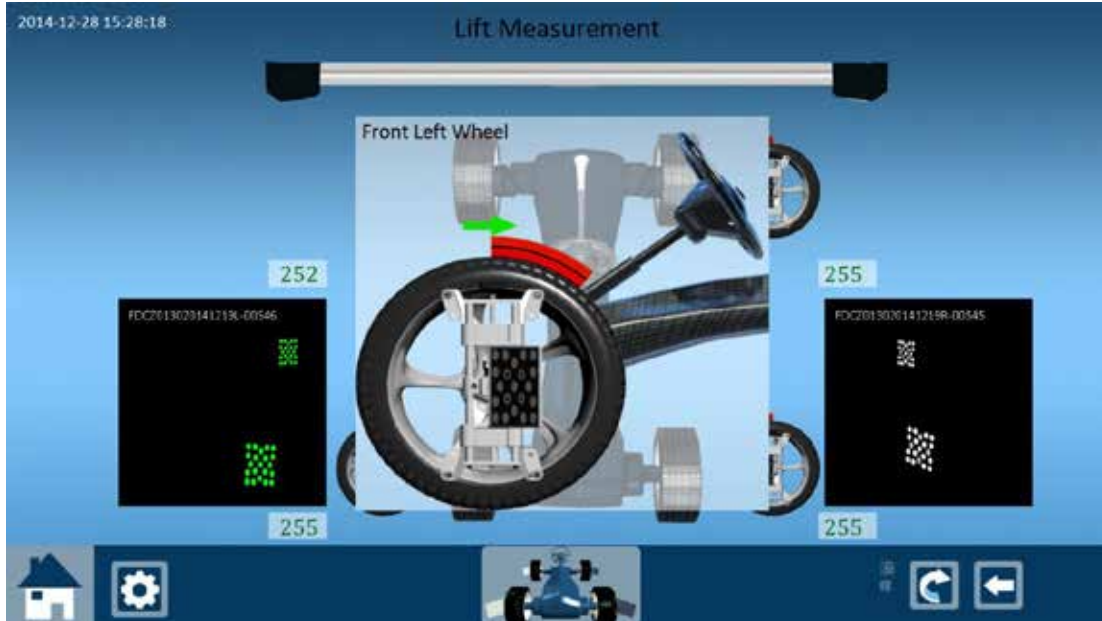

The front left wheel enlarge and appear turning path in red color, also has green arrow to indicate how to turn the wheel. So turn the wheel to tail direction slowly according to the indication.



When screen appear STOP indication, stop turning wheel and waiting for the next indication.

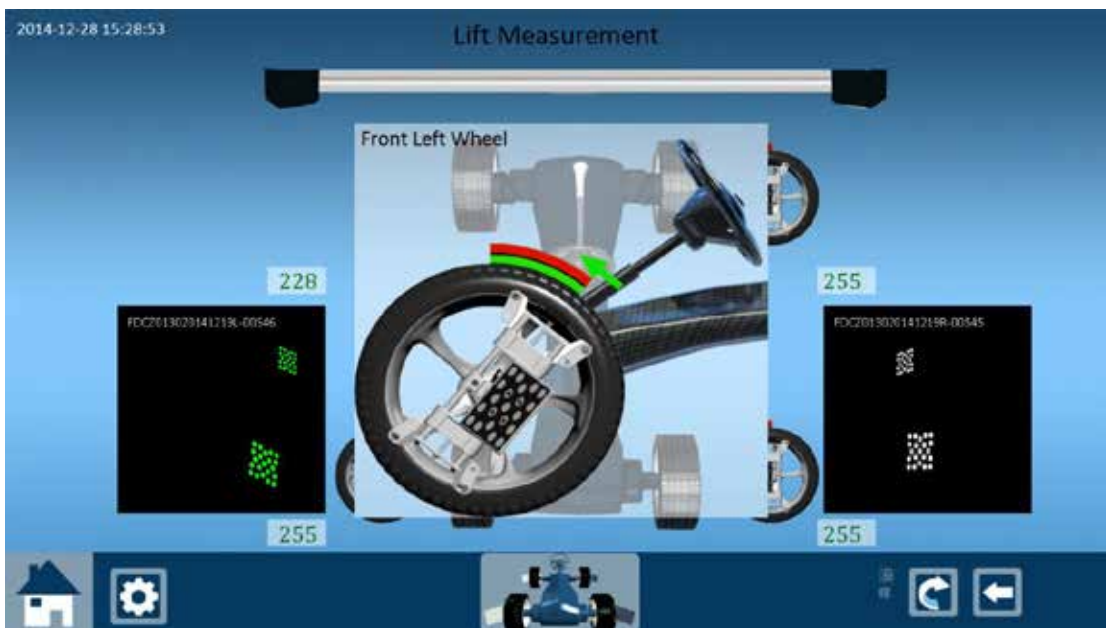

The screen appear the opposite direction indication, so the operator turn the wheel to the opposite head direction slowly according to the indication on the screen till back to the original position and appera STOP.



Waiting when appear STOP on the screen.



The front left wheel turn green and appear OK means the front left wheel measurment finished, other three wheels measurment repeat the same procedures.



After 4 wheels measurement all finished, let the 4 wheels of the vehicle on the lift or on the ground totally. Then strongly press vehicle head 3-4 times, strongly press vehicle tail 3-4 times, release the tires and suspension tension caused by vehicle elevated. Click next step to continue.





After lift measurement, enter “preparation before Caster measurement” screen.

5.5 Caster measurement

After measurement, enter “preparation before caster measurement”, operator need to pull up hand brake and lock pedal locker, shake the vehicle head and tail 3 times, let the suspension in release condition.



Caster Measurement

Operator can turn the steering wheel to different degree to measure different angles when make Caster measurement. Caster measurement has three ways: 10 degree, 20 degree and max. turning degree.

10 degree: Caster, KPI, included angle.

20 degree: Caster, KPI, included angle, toe out on turn.

Max.turning degree: Caster, KPI, included angle, toe out on turn, max. steering angle.

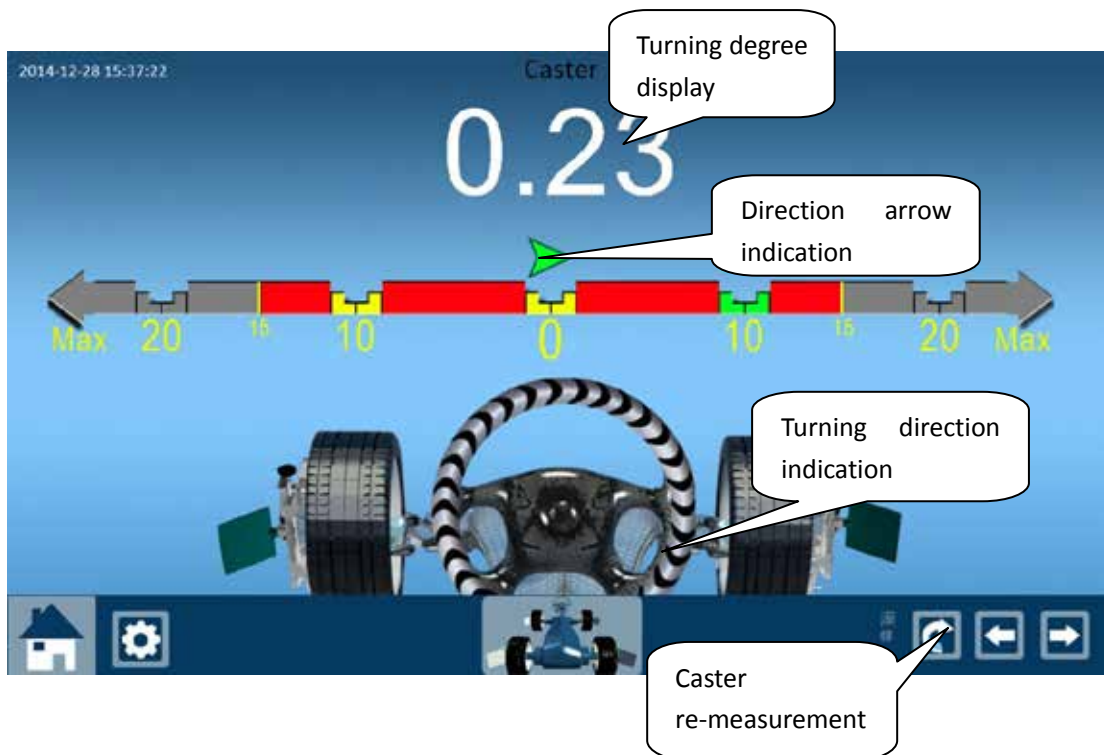

Caster measurement screen

5.5.1 10 degree Caster measurement

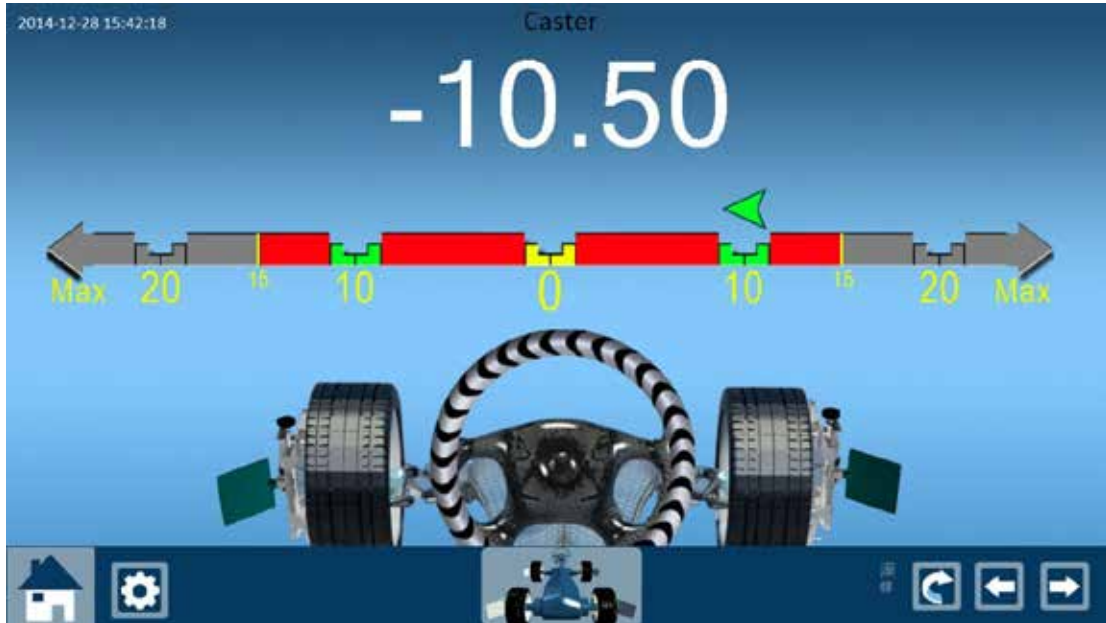

When the steering wheel turn to right direction exceed -10 degree, the steering wheel on the screen will indicate to turn to left direction, also the green arrow turn to left, so the operator need to turn the steering wheel to the left direction.

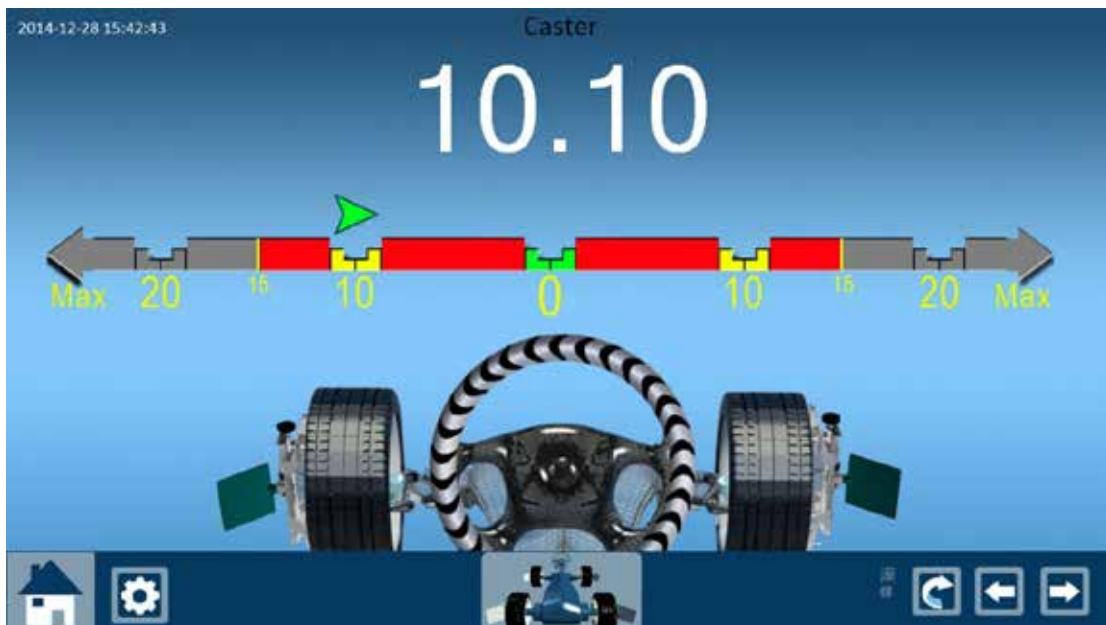

When the steering wheel turn to left direction exceed 10 degree, the steering wheel on the screen will indicate to turn to right direction to the center position, also the green arrow turn to right, so the operator need to turn the steering wheel to the right direction till the center position.



Stop turning steering wheel when the steering wheel exceed 0 degree, and the screen appear "STOP", waiting for the calculating results.

5.5.2 20 degree Caster measurement

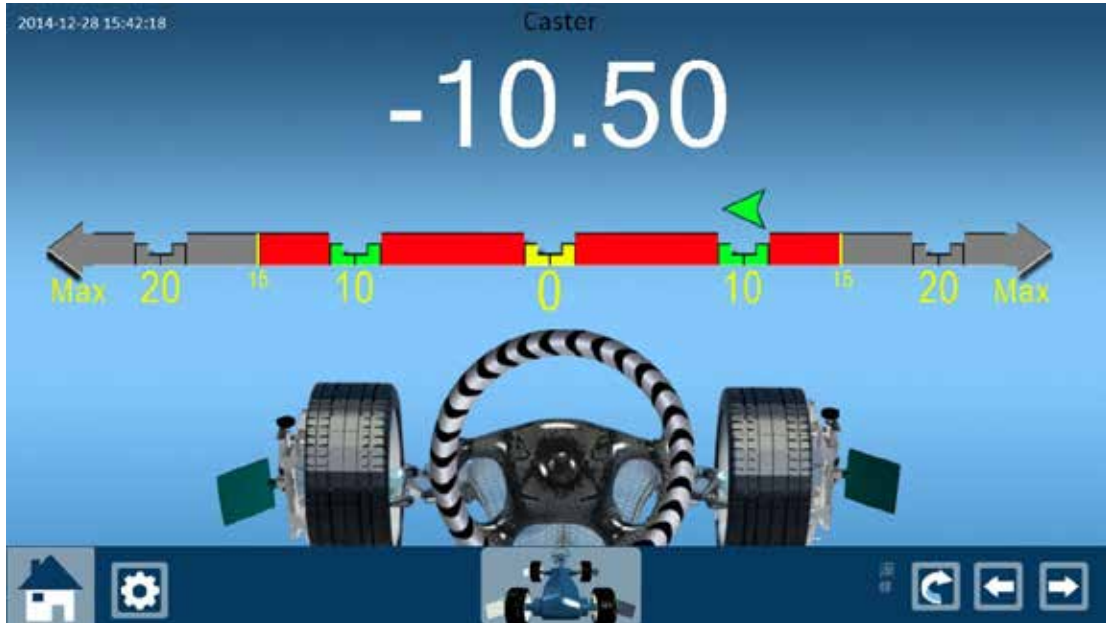

Operator turns the steering wheel to the right direction exceed -10 degree, continue to turn the steering wheel to the right direction exceed 20 degree.

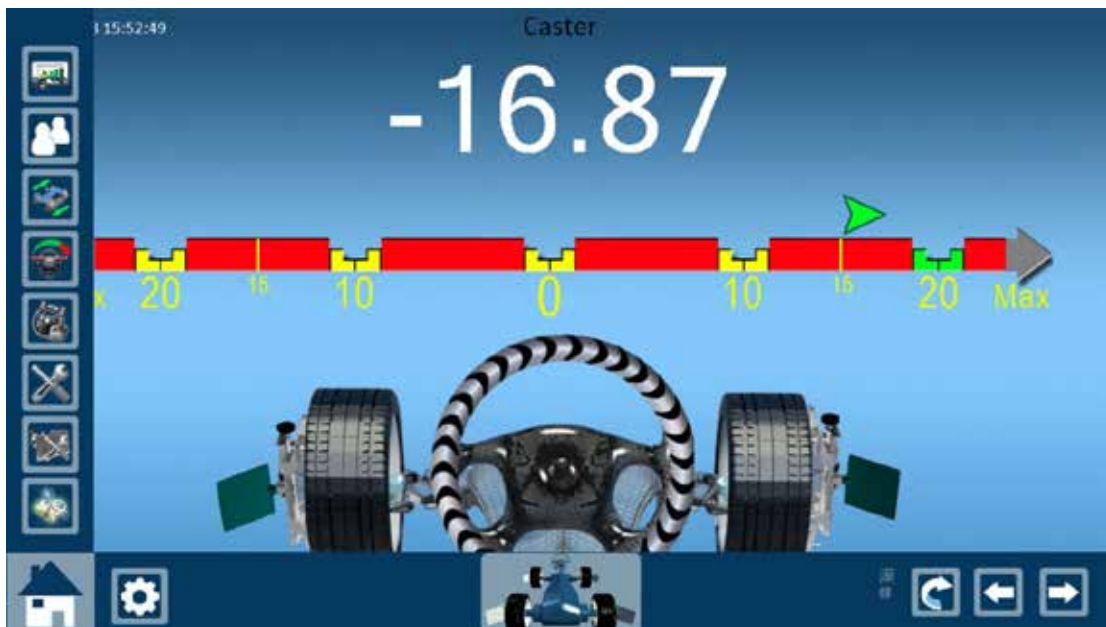

When turning the steering wheel to the right direction exceed -15 degree, steering wheel and arrow on the screen both indicate to turn to right direction.



When operator turns the steering wheel to the right direction exceed -20 degree, steering wheel and arrow on the screen both indicate to turn to left direction.

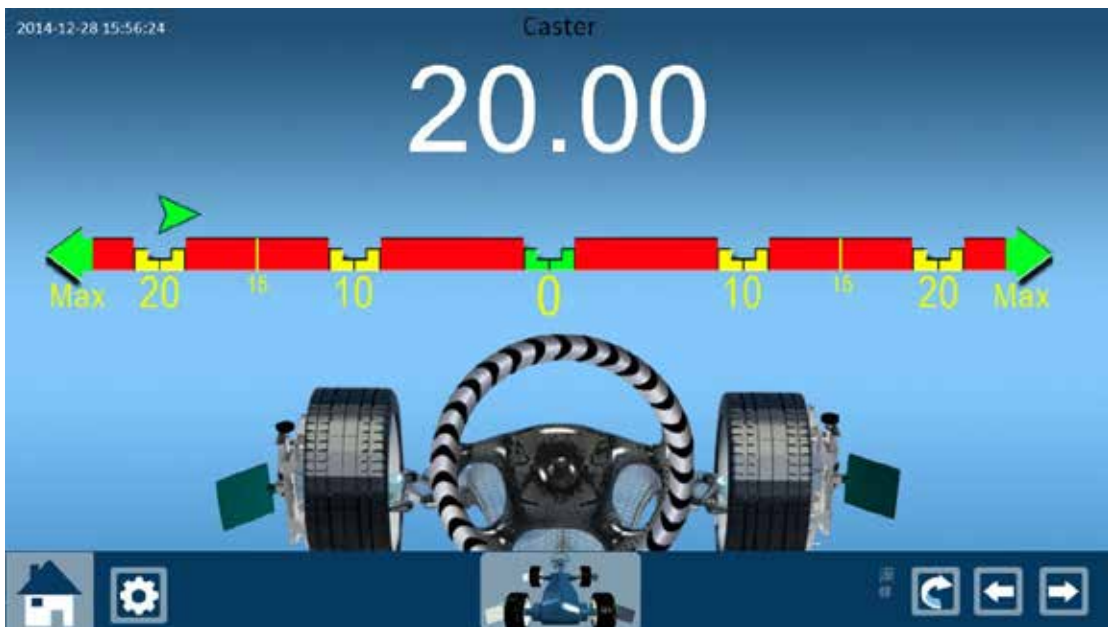

Operator turns the steering wheel to the left exceed 20 degree, steering wheel and arrow on the screen both indicate to turn to right direction to exceed 0 degree.



Stop turning steering wheel when the steering wheel exceed 0 degree, and the screen appear “STOP”, waiting for the calculating results.

5.5.3 Max.turning degree Caster measurement

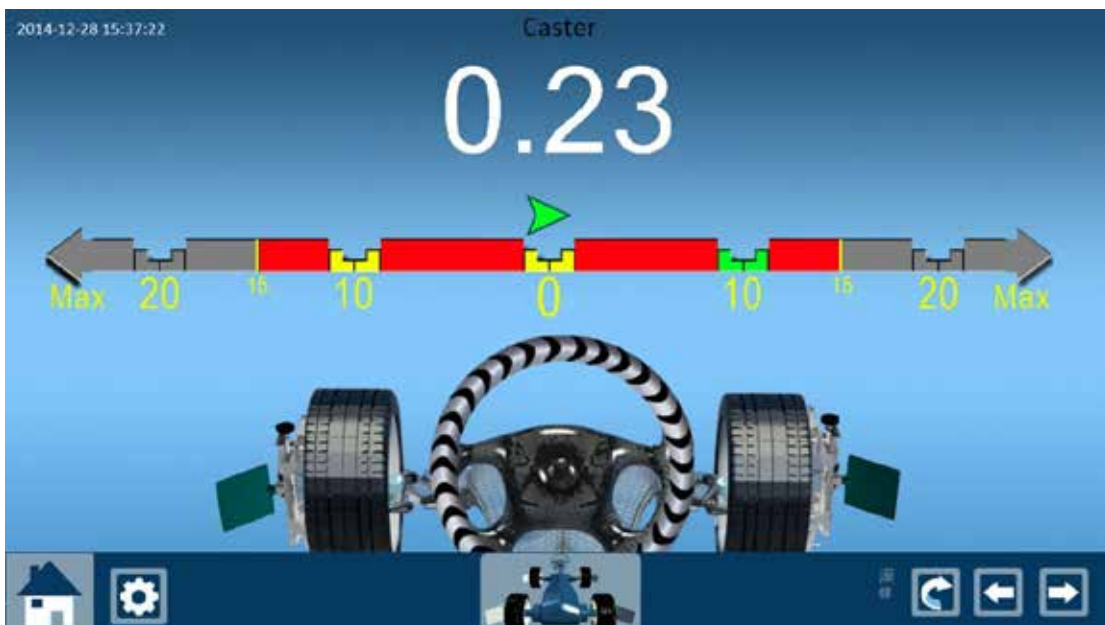

Enter Caster measurement screen, turn the steering wheel to right direction from beginning.

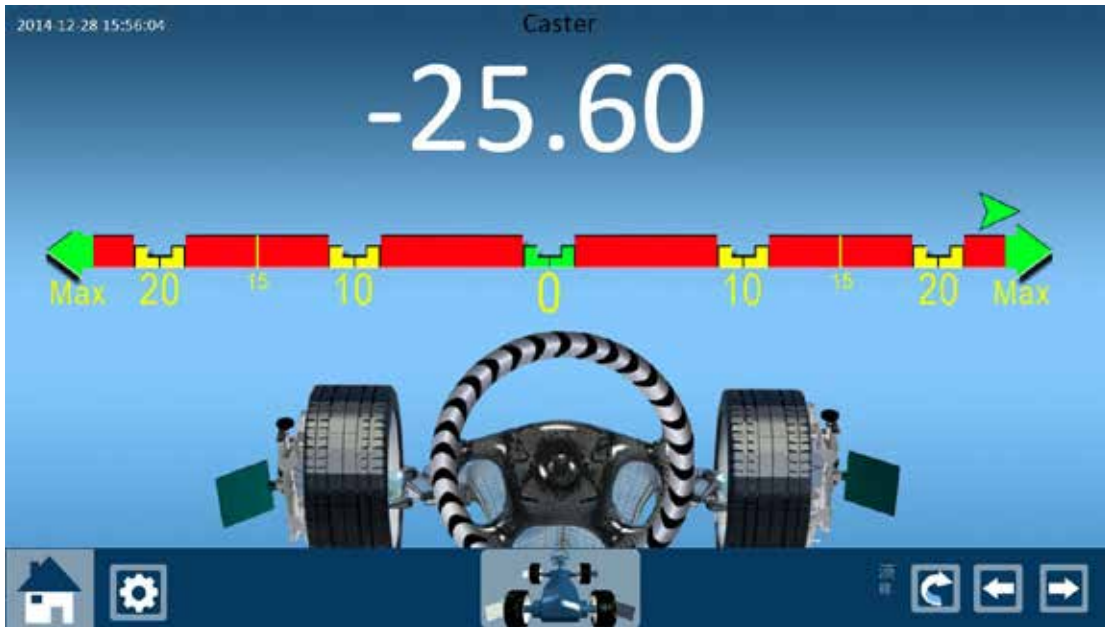

Turn the steering wheel to the right direction till can't turn and stop, then turn the steering wheel to the left direction after 2 seconds.

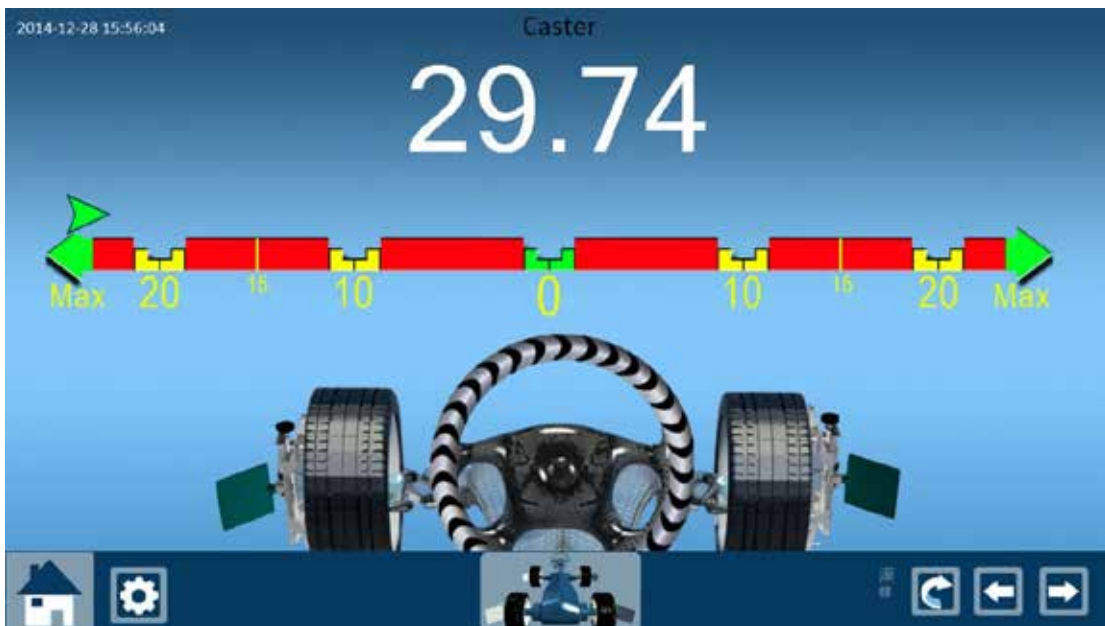

Turn the steering wheel to the left direction till can't turn and stop, then turn the steering wheel to the center position after 2 seconds.



Stop turning steering wheel when the steering wheel exceed 0 degree, and the screen appear “STOP”, waiting for the calculating results.

5.6 Straighten the steering wheel by eye

5.6.1 Four wheel alignment straighten the steering wheel by eye

When choose four wheel alignment, operator can enter “straighten steering wheel by eye” screen after push vehicle measurement directly, or after Caster measurement. There are four steps indications on the screen, the operator must do them before click next step to “report before adjustment”, or will affect the adjustment precision.



straighten steering wheel by eye

5.6.2 Two wheel alignment straighten the steering wheel by eye

When choose two wheel alignment, operator can enter “straighten steering wheel by eye” screen after push vehicle measurement directly, or after Caster measurement. But first, it need to confirm if the steering wheel of the measured vehicle has offset during driving. It need to click “revise thrust line manually” button to revise the thrust line if has offset.

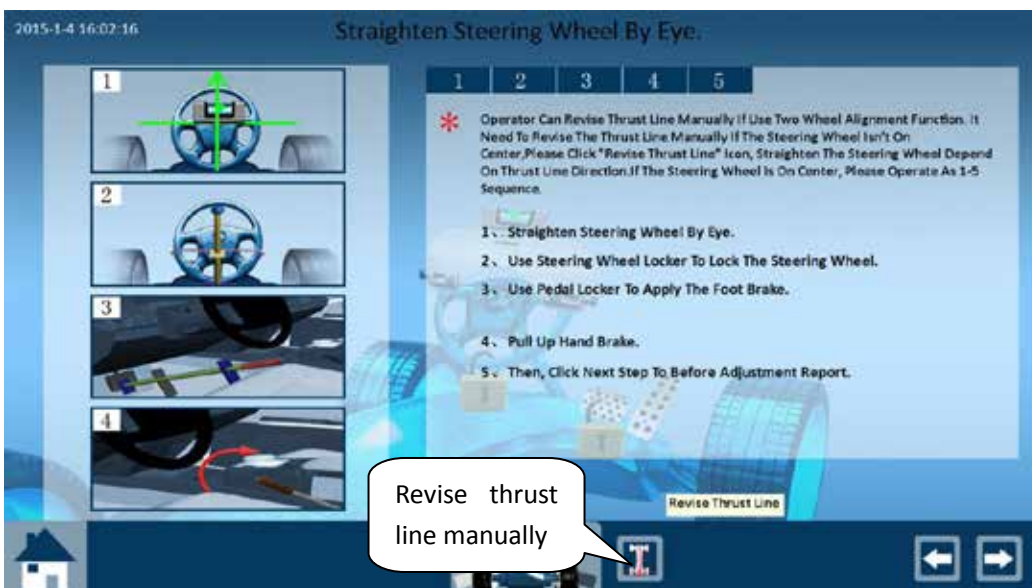

Enter “revise thrust line” screen, operate according to the three steps indications on the screen, then click next step to “straighten steering wheel by eye” screen, then there are four steps indications on the screen, the operator must do them before click next step to “report before adjustment”, or will affect the adjustment precision.

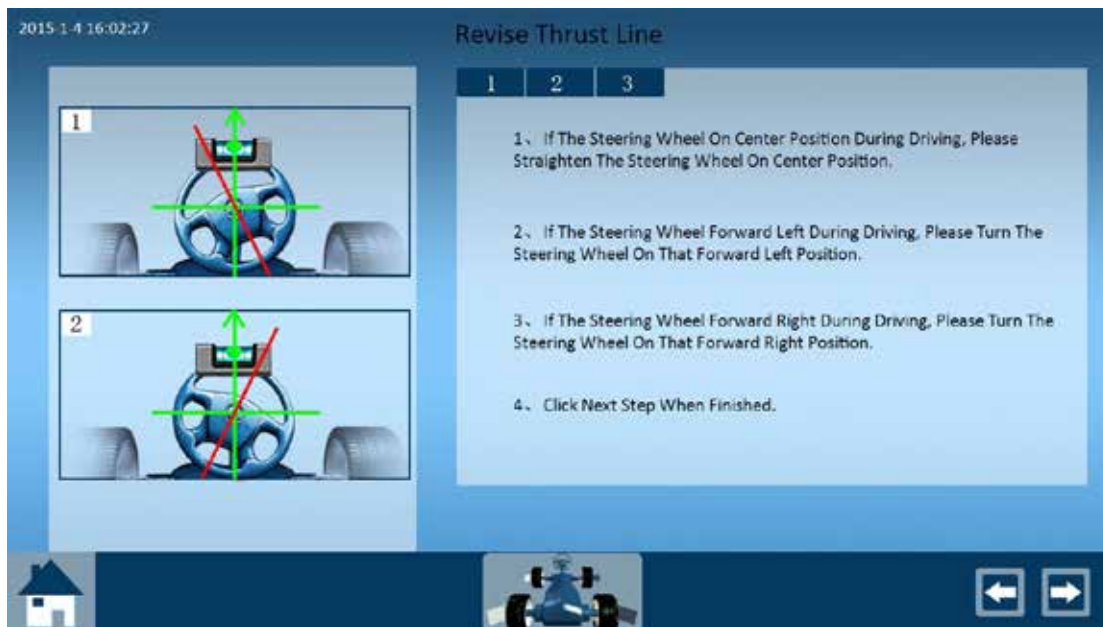

5.7 Report before adjustment

2014-12-29 10:20:42

Report Before Adjustment

	Before Adjustment			Standard		
	Left		Right	Min. Value	Standard	Max. Value
 Total Toe		6.90°		-0.27°	-0.13°	0.00°
Toe	1.08°		5.82°	-0.13°	-0.07°	0.00°
Camber	-5.50°		0.90°	-0.58°	-0.50°	0.42°
Caster				4.75°	5.12°	5.48°
KPI						
Toe-out on Turns						
Max. Steering Angle						
Set-back Angle	78mm					
 Total Toe		-0.38°		0.27°	0.40°	0.53°
Single Toe	3.20°		3.60°	0.13°	0.20°	0.27°
Camber	-6.00°		4.24°	-1.58°	-1.50°	-1.42°
Thrust Angle		-3.45°				
Set-back Angle	88mm					

At the bottom of the screen, there are navigation icons: a home icon, a gear icon, a car icon, a person icon, and left/right arrow icons.

Chapter 6 Adjustment

Operator need to enter adjustment function after “report before adjustment”. The adjustment procedure should be: Caster adjustment (if operator made Caster measurement), rear wheels adjustment, front wheels adjustment. If the operator skip Caster measurement, the adjustment procedure should be: rear wheels adjustment, front wheels adjustment. And it needs to adjust Camber first, then adjust Toe.

6.1 Adjustment widgets explanation

3D software adjustment widgets divided as “pointer type of oil gauge” and “digital type”. Adjustment screen will display the adjustable information by ruler, number, pointer and color.

It displays the minimum and maximum value of standard value under the ruler. The dynamic value above the ruler is the current measuring data. The display area color represents the relationship between the dynamic value and standard value. Red color means the measuring data is out of standard vehicle specification range, so need to adjust. Green color means the measuring data within the standard specification range.

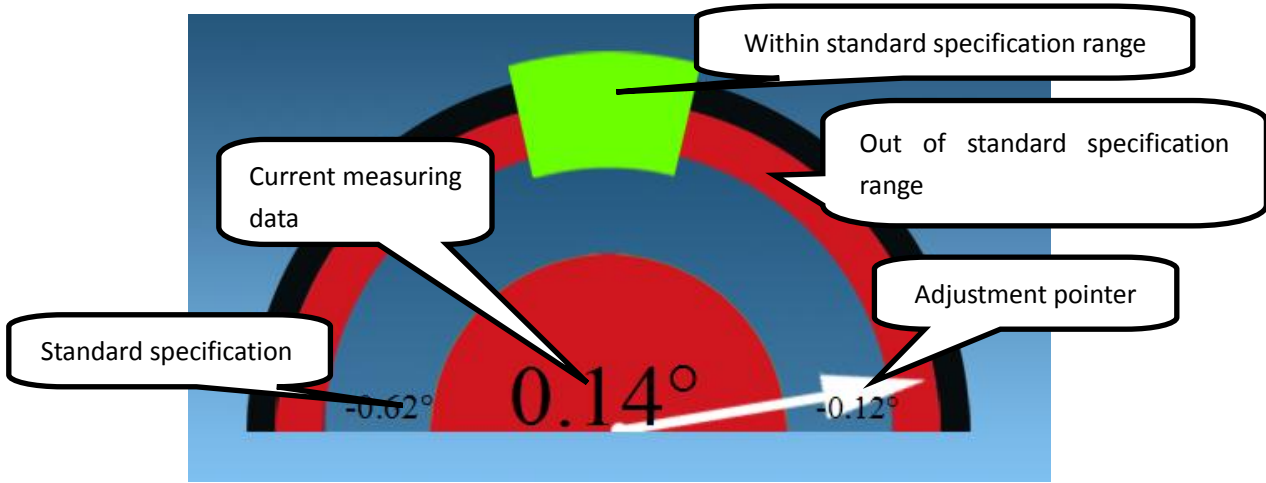

Pointer type of oil gauge

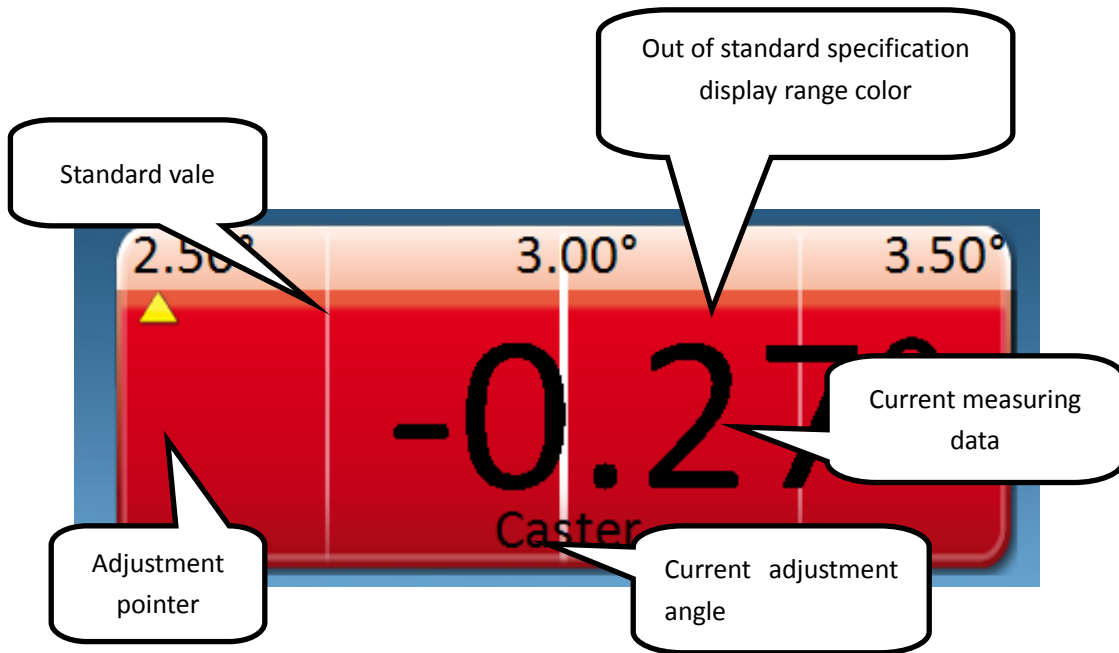

Digital type

6.1.1 Pointer type of oil gauge status explanation

Current measuring values has big difference with standard vehicle specification

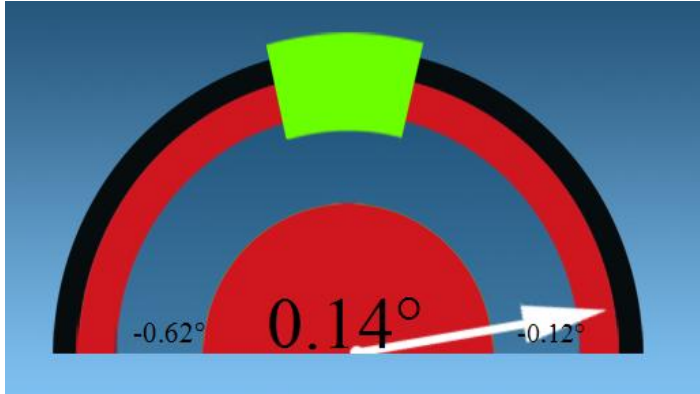

Current measuring values near the standard vehicle specification.

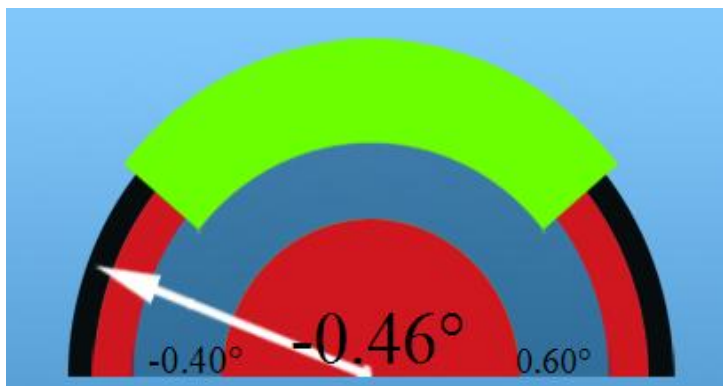

Current measuring values within the standard vehicle specification range.

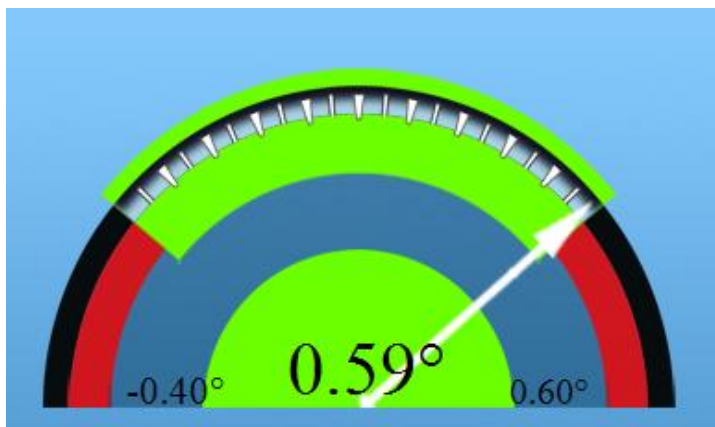

6.1.2 Digital type status explanation

Current measuring values has big difference with standard vehicle specification

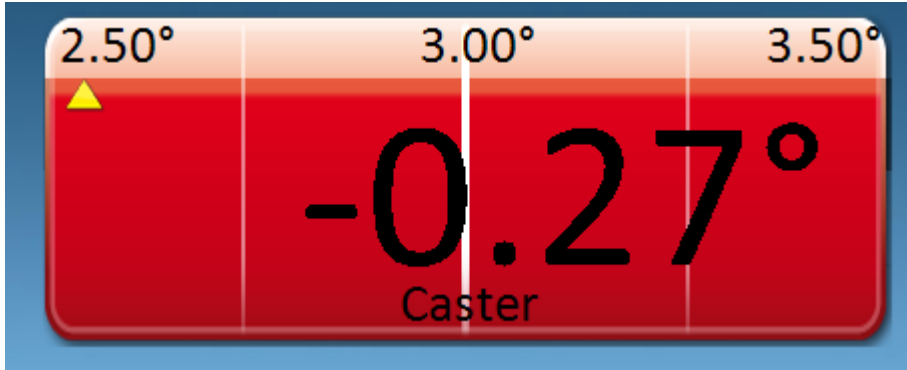

Current measuring values near the standard vehicle specification.

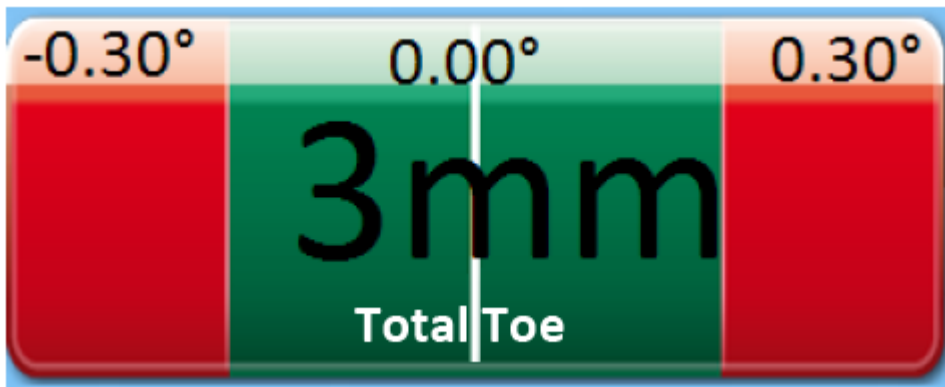

Current measuring values within the standard vehicle specification range.



6.1.3 Enlarge the adjustment values

If the operator is far away from the monitor when adjustment, the operator can click the value to enlarge it, thus will be more convenient for the adjustment. Click any place again will be back to original size.



6.1.4 Unit convert

Operator click "unit convert" button can convert the value display way, it can convert from "degree" to "degree and minute". Also can convert Toe unit to "mm" and "inch". Toe unit convert need to input tire diameter of the measured vehicle.

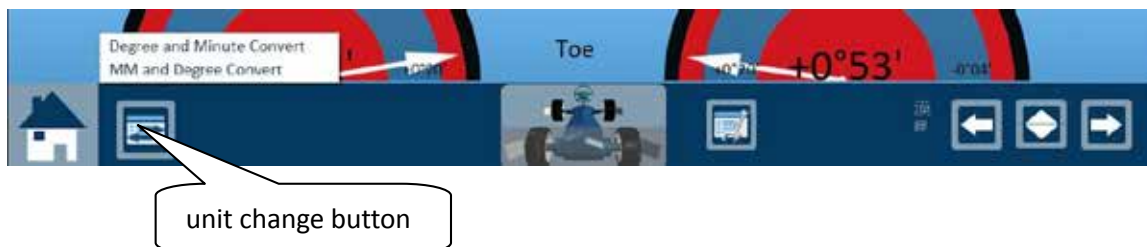

6.1.4.1 Degree and minute unit convert

Operator click the unit convert button to choose “degree and minute convert”, the system will convert the unit of adjustment value from degree to degree and minute, or from degree and minute to degree.



6.1.4.2 Toe unit convert

Operator click the unit convert button to choose “mm and degree convert”, system will appear the dialog box to require to input the wheel diameter first. And then click confirm to convert.



Choose rim diameter

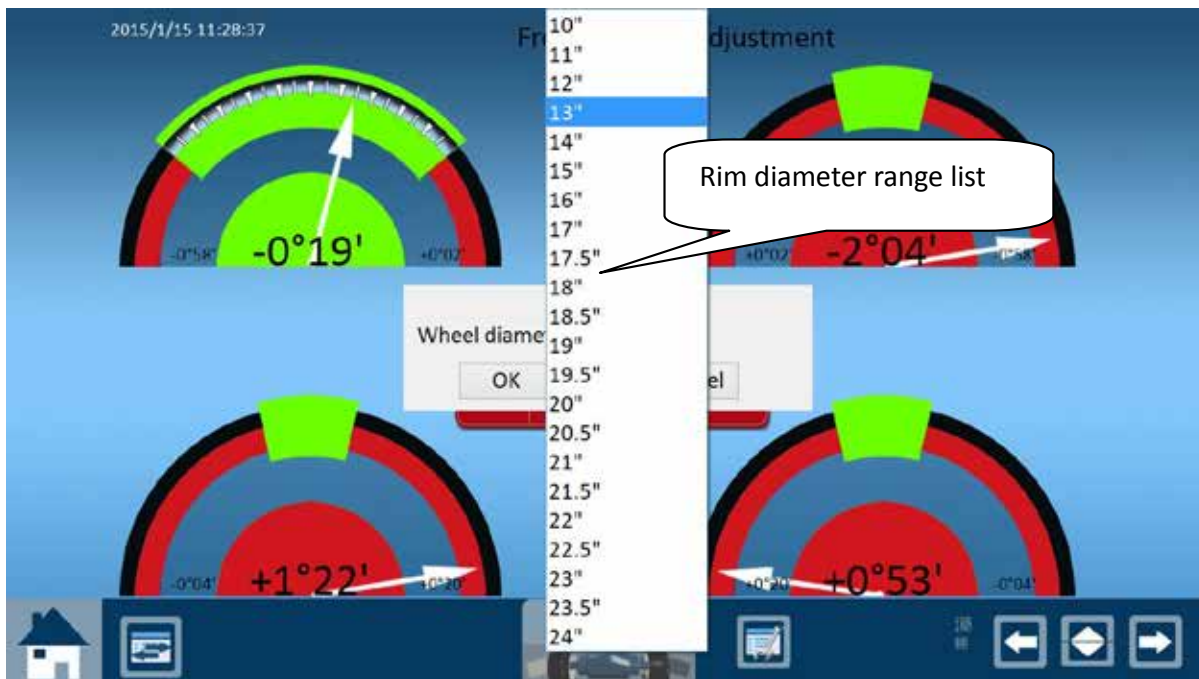

choose rim diameter from the list

6.2 Check summary measurement values

Summary measurement values are all the measuring values after alignment, these values for the operator to judge the real situation of the measured vehicle. Click the “turn page” button or press up key of the keyboard on adjustment screen can check all the measurement values and additional values.

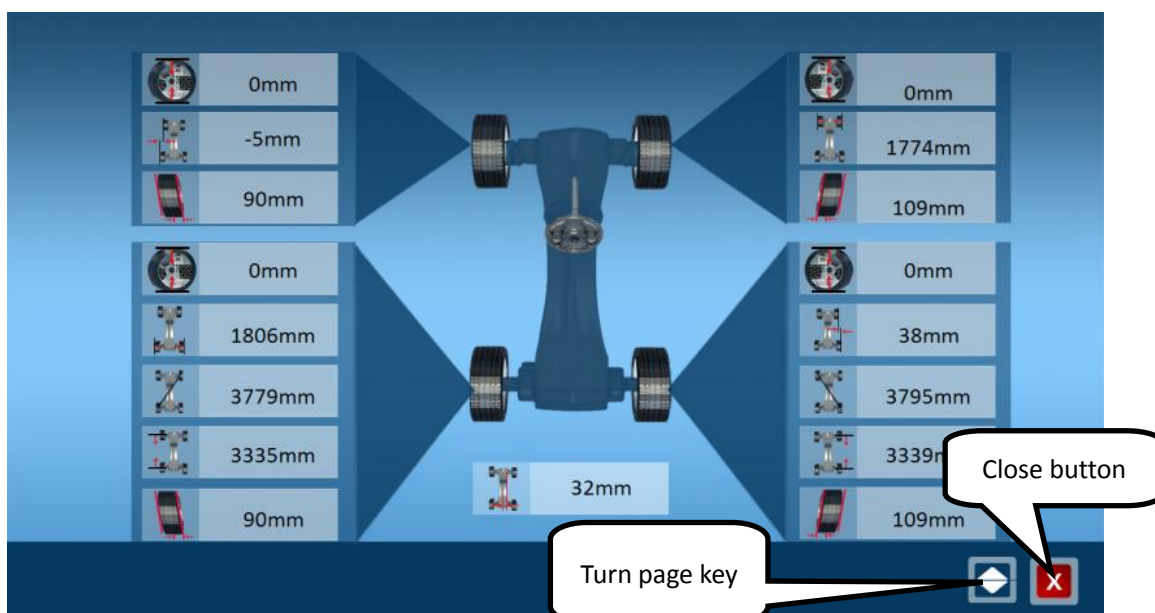

Additional data

6.3 Caster adjustment

Attentions before Caster adjustment

It must use steering wheel locker to lock the steering wheel after straighten the steering wheel by eye, also use the pedal locker to lock the pedal and pull up the handbrake.

The operator can click menu button to choose “re-measure Caster” item if wants to re-measure the Caster.

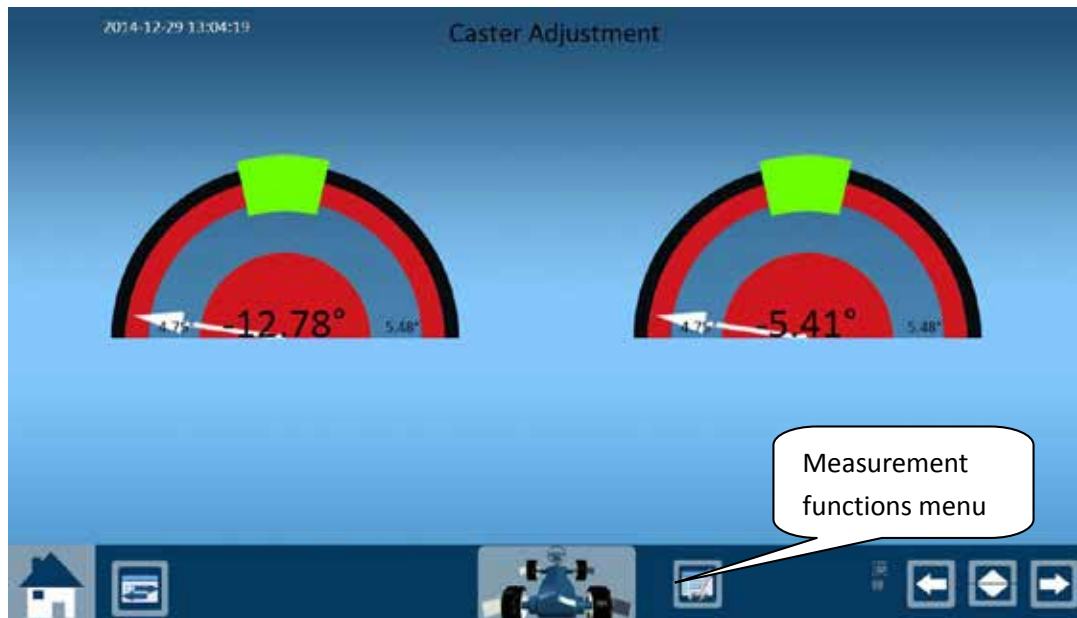

6.4 Rear wheels adjustment

Enter rear wheels adjustment screen after Caster adjustment.

Rear wheels adjustment procedure: Camber, Toe. Click next page enter individual rear wheel Camber adjustment, rear wheel Toe adjustment, thrust angle adjustment. There are lift adjustment, single wheel measurement and other functions on rear wheel adjustment screen.

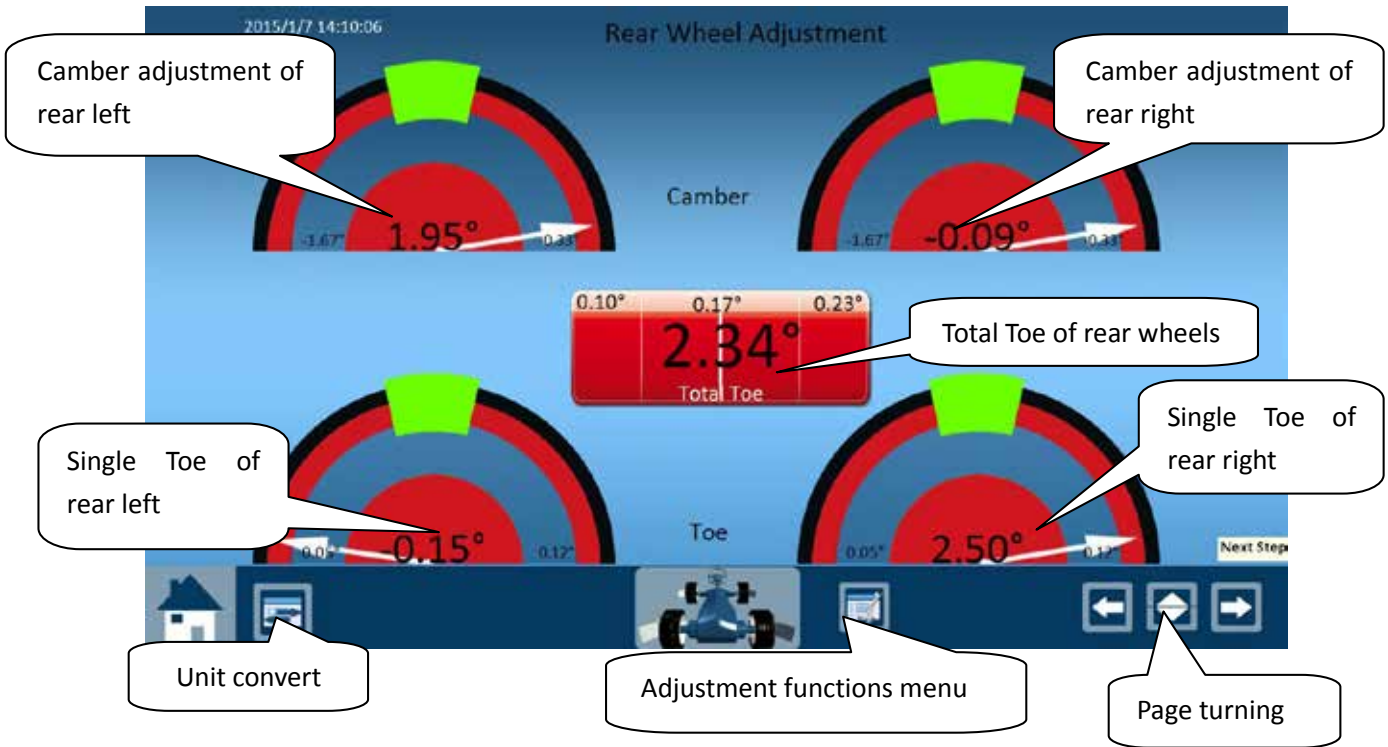

Individual adjustment of rear wheel Camber



Individual adjustment of rear wheel Toe



Individual adjustment of rear wheel thrust angle

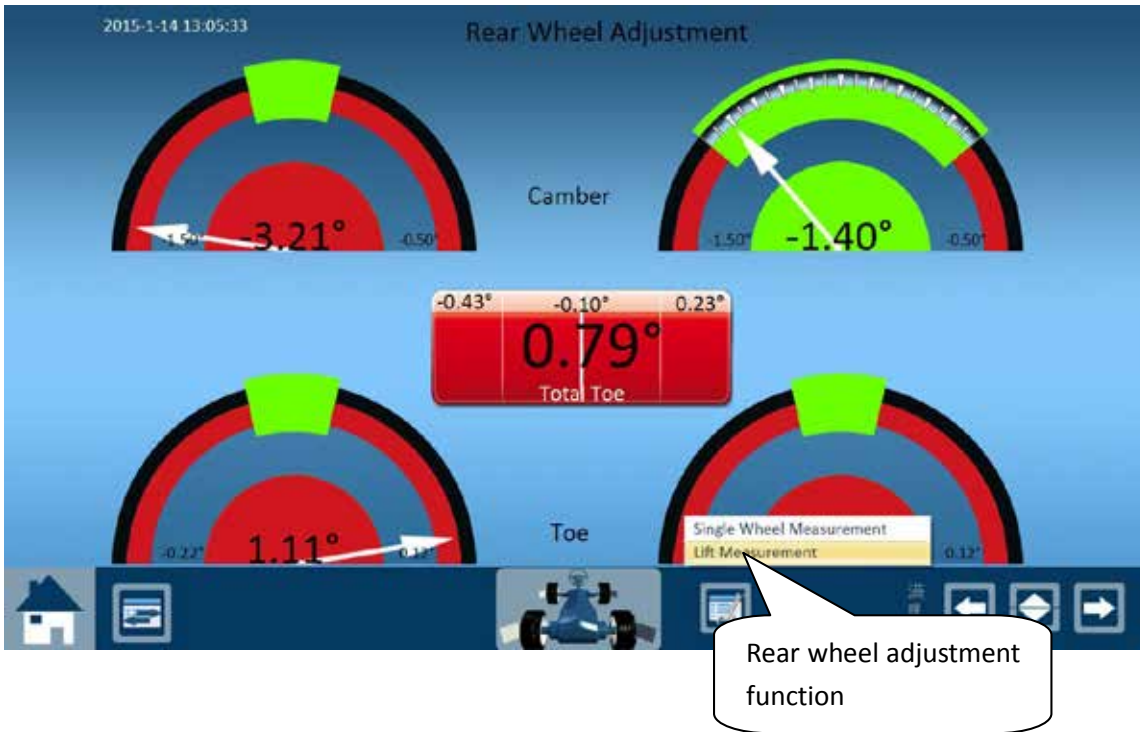

6.4.1 Lift adjustment way

Operator click adjustment menu and choose lift adjustment item to enter lift adjustment screen. Then the operator must prepare according to the indications on the screen before lift adjustment operation.

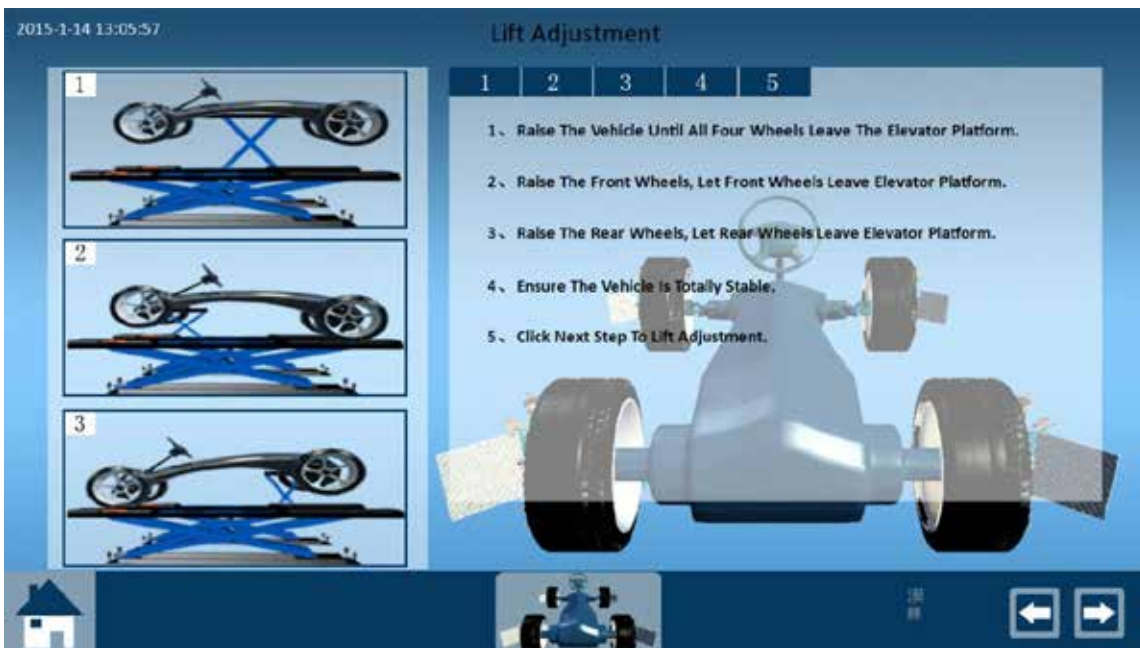

Operator can adjust based on standard specification on the adjustment screen, and click close after adjustment.



After adjustment and click close button will enter below screen, the operator must operate according to the indications on the screen. Then click close to back to adjustment screen.



6.4.2 Single wheel measurement

If need to disassemble the tire during adjustment procedure, it doesn't need to back to measurement screen after adjustment, only need to choose "single wheel measurement" after click "adjustment function menu" on adjustment screen. Elevate the measured wheel, re-measure the wheel according to the indications on the screen.

Enter single wheel measurement screen, operator choose the wheel that need to re-measured, click the corresponding wheel on the screen to enter next step. Click close to exit.

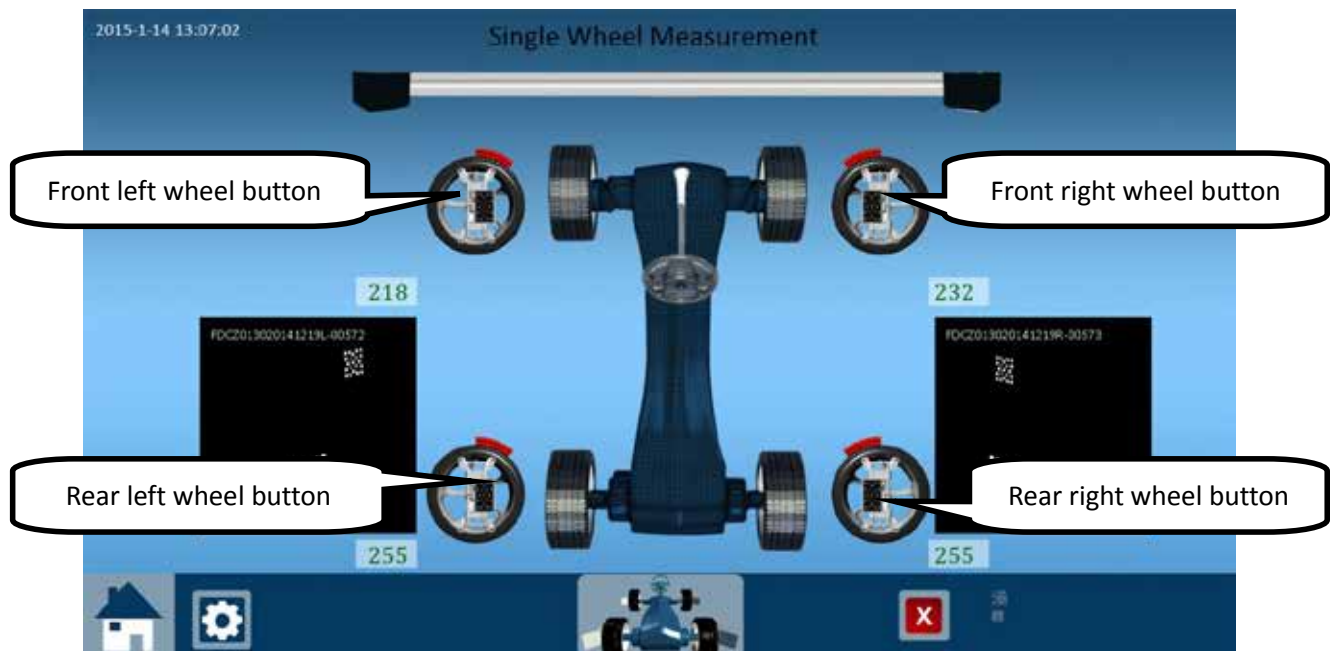

We use front left wheel for example, click front left wheel icon on the screen to enter front left wheel measurement. Operator turns the wheel to the tail direction according to green arrow indication.

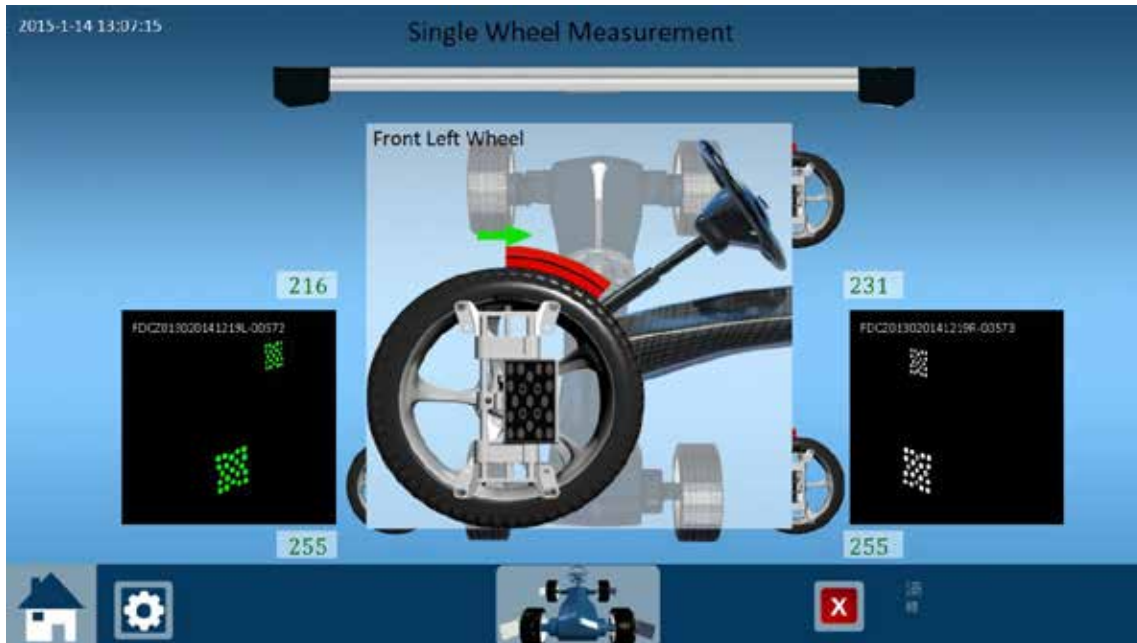

Stop turning the wheel when appears STOP, and waiting for indication.



Turn the wheel to head direction when appears opposite arrow indication.

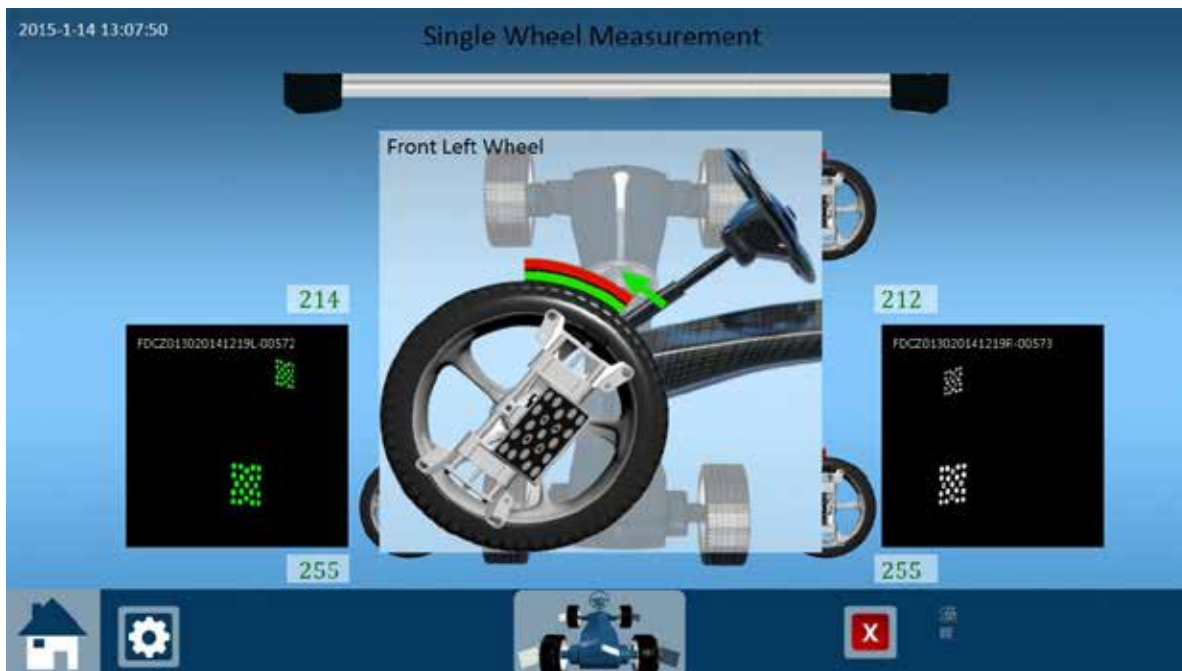

Stop turning the wheel when appears STOP on the screen, and waiting for calculating results.



It appears OK on front left wheel means front left wheel measurement is finished. Repeat the same procedure if need to measure other wheels, or click close to exit.



6.5 Front wheels adjustment

Click next step to enter front wheels adjustment screen after rear wheels adjustment.

Front wheels adjustment procedure: Camber, Toe. There are many items can be chosen after click front wheels adjustment menu. Individual adjustment function is the same as rear wheels adjustment.

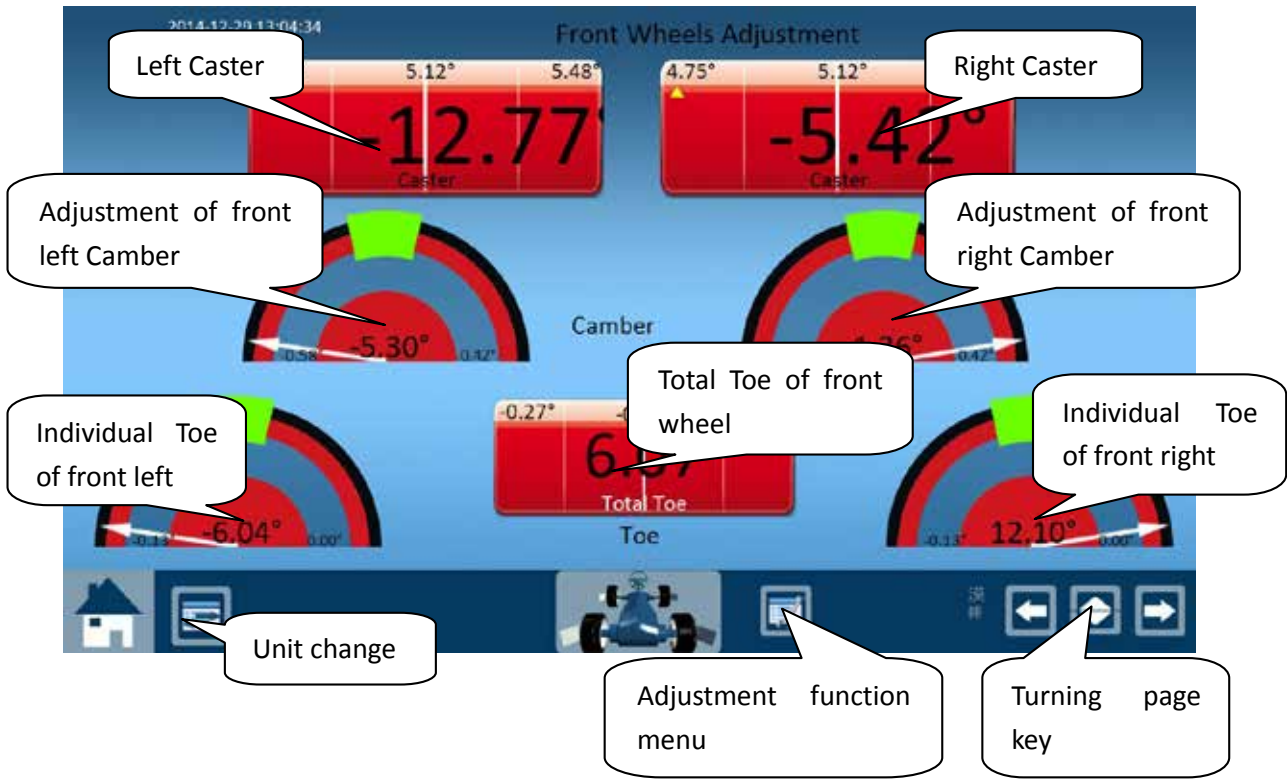

6.5.1 Front wheels adjustment-steering wheel adjustment

Choose “straighten steering wheel” item on the front wheels adjustment screen.



Enter “steering wheel adjustment” screen, operator must adjust the value very close to 0 based on the values display on the screen, then means the steering wheel on the center position.

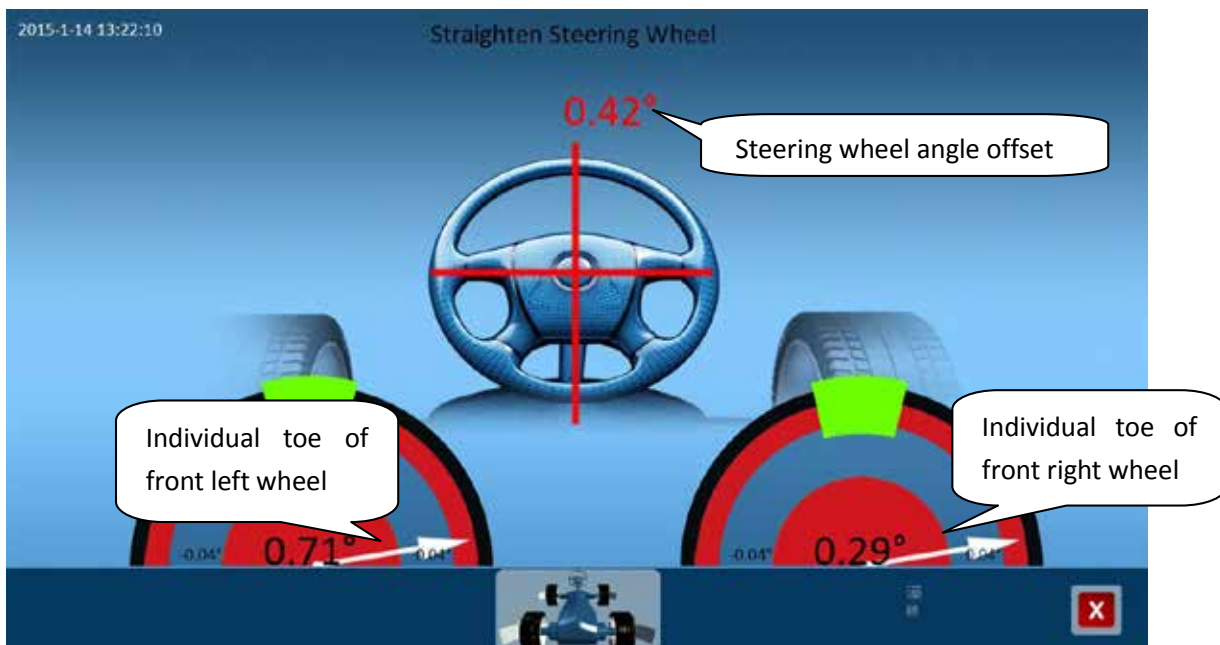

6.5.2 Front wheels adjustment- Toe lock adjustment

Choose “Toe lock adjustment” item on the front wheels adjustment screen. Toe lock adjustment used for the vehicle steering link and bar adjustment position is narrow, not easy to adjust.

Operation way: turn the wheel to enlarge the space to adjust steering link and bar.



Enter “Toe lock adjustment” screen and operate according to the indications on the screen, then click next step.



Still operate according to the instructions on the screens, and click next step.



Turn steering wheel according to the standard specification to adjust one side Toe, then click next step after finished.



Operator can continue to adjust the other side Toe after one side Toe adjustment finished. Operate according to the indications on the screens. Click close if adjustment finished.



After Toe adjustment, operator still need to operate according to the indications on the screens, and click close button.



6.5.3 Front wheels adjustment-Measure Camber at zero Toe

Operator choose “Measure camber at zero Toe” function on the adjustment screen. This function used for Caster value is too large, Toe value change will affect Camber value during the adjustment, so the correct Camber value should when Toe is zero.



Enter “Measure Camber At Zero Toe” function, operate according to the indications on the screen.

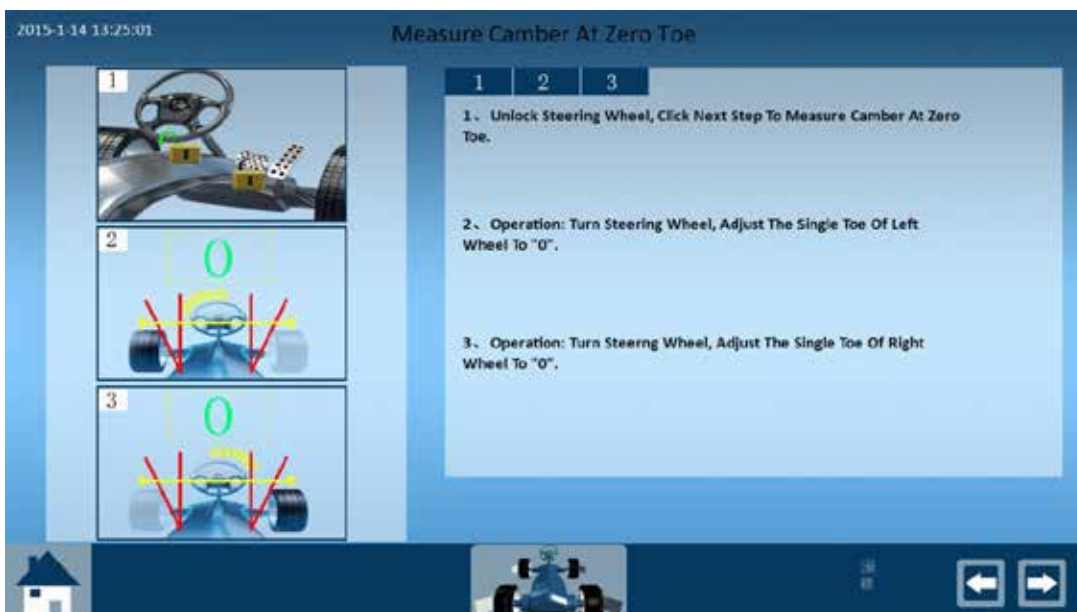

On the adjustment screen, operator turn the steering wheel according to the screen indication, let the Toe of front left is very near 0.

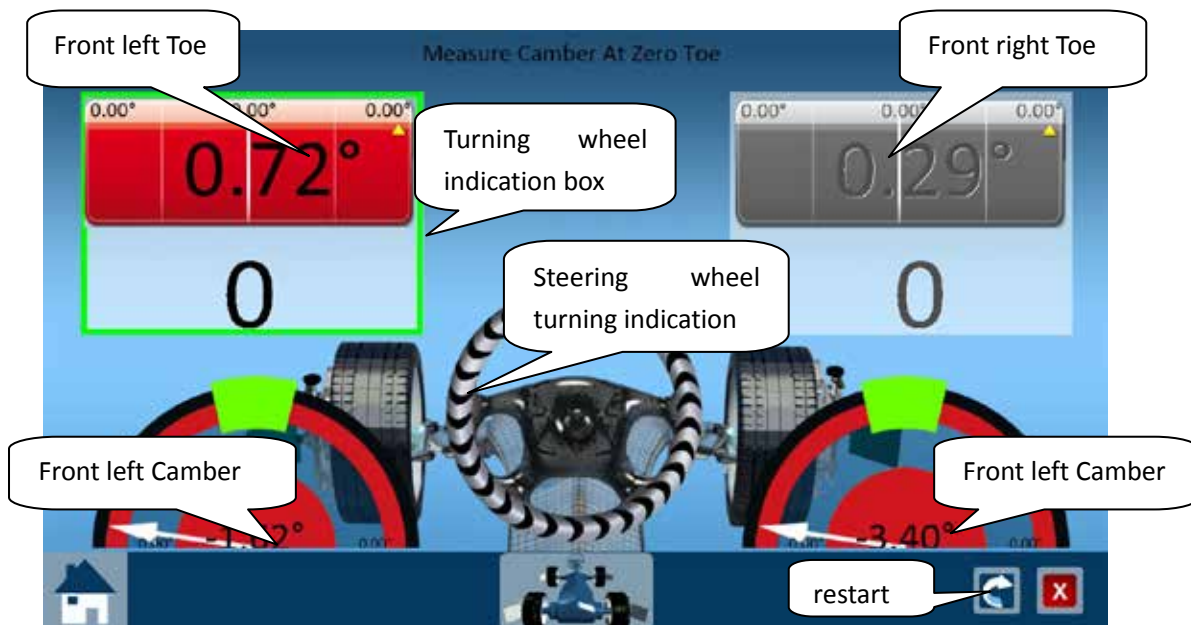

When operator turn the steering wheel to near 0, the turning indication will stop, and screen will appear STOP and steering wheel on the screen turn green. At this time, operator must stop turning the steering wheel and wait.



After waiting, the screen display Camber of front left update finished. The turn steering wheel indication transfers to front right wheel. The operator repeats the same operation procedure as front left wheel.

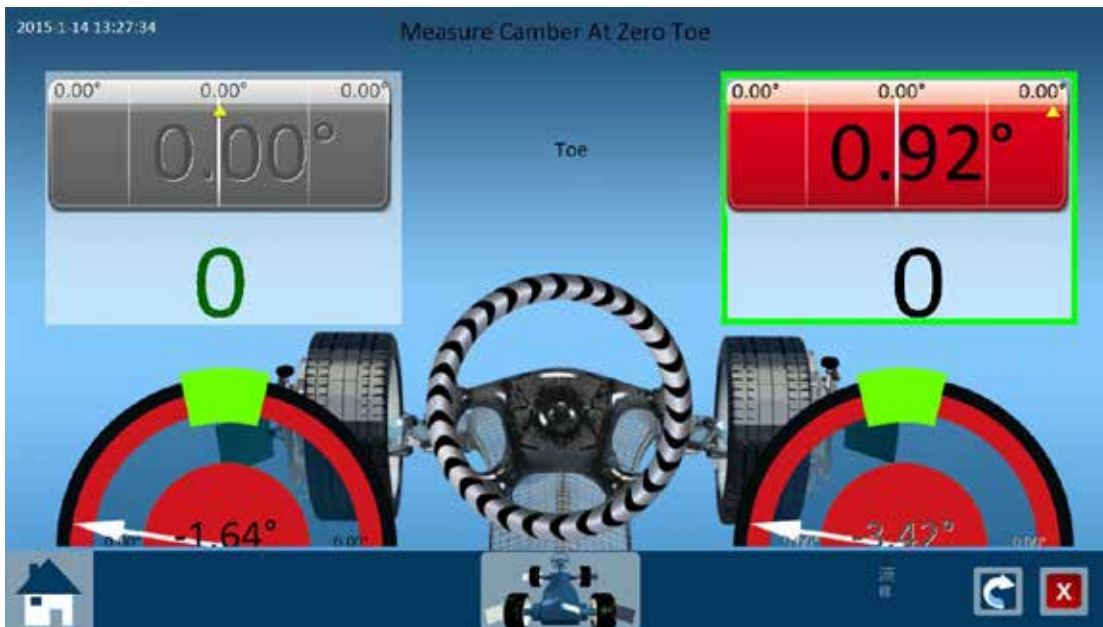

When finished, click close to enter next screen. Operate according to the indications on the screen and click close button to back to adjustment screen.



Front right wheel measurement finished, click close button to exit.

Enter "Measure Camber at Zero Toe" screen after exit. Operation according to the indications on the screen and click close button back to the adjustment screen.



Chapter 7

7.1 Report after adjustment

Operator click next step on front wheels adjustment screen will enter report after adjustment screen. There are values before adjustment and after adjustment, also the standard specification on this screen.

2014-12-29 10:44:45

Report After Adjustment

	Before Adjustment			Standard			After Adjustment		
	Left		Right	Min Value	Standard	Max Value	Left		Right
									
Total Toe		0.84		-0.27°	-0.33°	0.00°		0.84	
Single Toe	0.24°		0.79°	-0.33°	-0.07°	0.00°	0.24°		0.80°
Camber	0.11°		0.40°	0.58°	-0.50°	-0.42°	0.11°		0.40°
Caster	3.27°		2.18°	4.75°	5.12°	5.48°	1.23°		2.14°
KPI	-5.43°		25.05°				-5.43°		25.05°
Toe-out on Turns									
Max. Steering Angl									
Set-back Angle		-22mm							-22mm
									
Total Toe		1.53°		0.27°	0.40°	0.53°		1.33°	
Single Toe	1.12°		0.41°	0.13°	0.20°	0.27°	1.27°		0.41°
Camber	2.20°		-0.07°	-1.58°	-1.50°	-1.42°	2.09°		0.07°
Thrust Angle		0.36°						0.36°	
Set-back Angle		-4mm						-4mm	

Chapter 8 System Maintenance

There is “system maintenance” button on each software program screen, operator can enter “system maintenance” to set system parameters or make calibration.



System maintenance screen include: system setting, camera calibration (RCP), camera view, and vehicle data adding.



Note: only the professional people can do the relevant setting. The wrong settings will lead to wrong measurement results. So please read this chapter instructions carefully.

8.1 System setting

Click “system setting” to enter the setting screen. It includes: system parameters, language selection, password modification, system information backup, and relevant information.

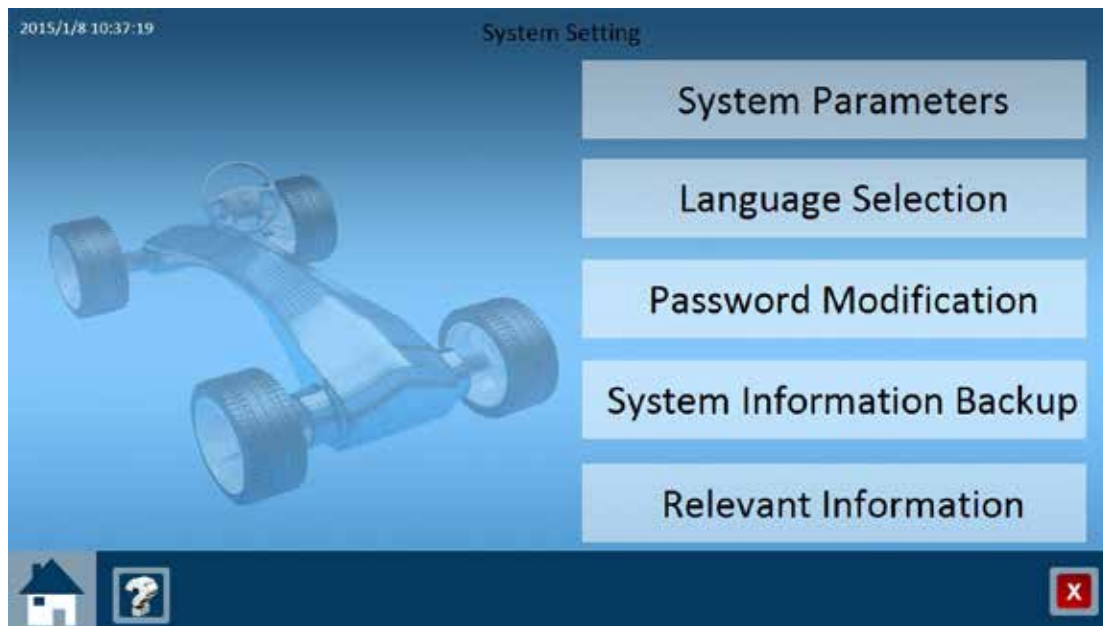

8.1.1 System parameter

On “system parameter” screen, choose the modified item and click save button.

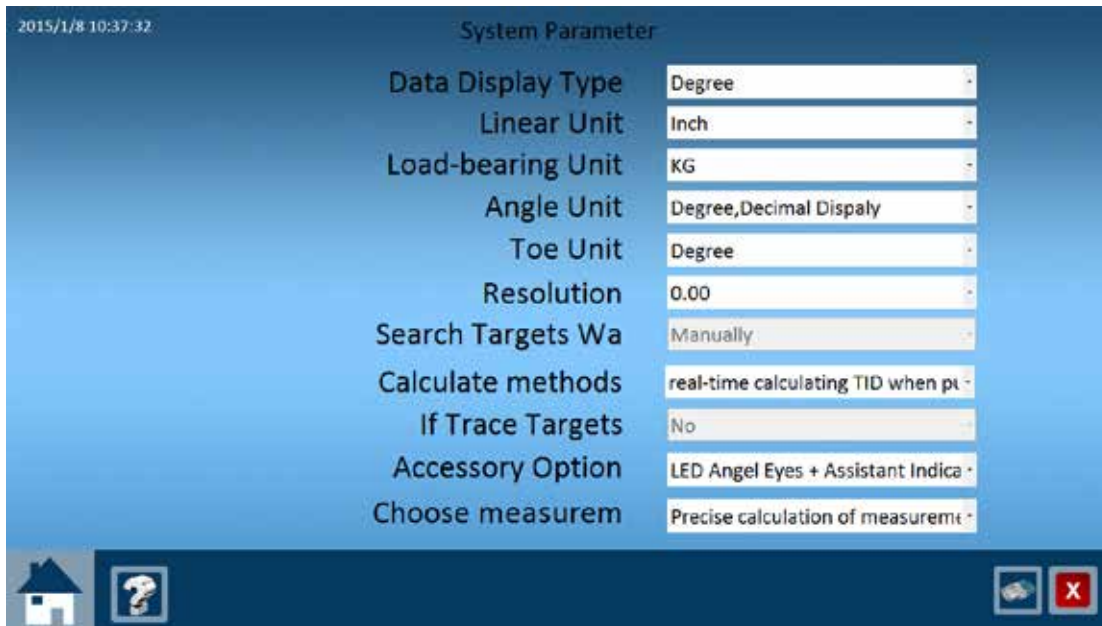

Items on system parameter screen explanation:

- ◆ Data display type: degree, decimalism, degree and minute, degree, minute.
- ◆ Linear unit: inch, mm.
- ◆ Load-bearing: KG, pound.
- ◆ Angle unit: 1.99°, 1°59'.
- ◆ Toe unit: degree, MM, inch.
- ◆ Resolution: 0.00, 0.0.
- ◆ Search target way: manually, automatically.
- ◆ If trace targets: No, Yes.
- ◆ Accessory option: LED angel eyes, assistant indicator.
- ◆ Choose measurement way: precise calculation of measurement results, quick calculation of measurement results.

8.1.2 Language selection

Click the flag icon to choose the language that customer need.



8.1.3 Password modification

The screenshot shows a window titled "Password Modification" with a timestamp of "2015/1/8 10:38:13". The interface contains three input fields for password modification:

- Input Old Password**: A white text input field.
- Input New Password**: A white text input field.
- Input New Password Again**: A white text input field.

At the bottom, there is a navigation bar with a home icon, a help icon, a refresh icon, and a close button (X).

8.1.4 System information backup

Customer can backup camera ID, parameter files and calibration files on “system information backup” screen. It needs to input password 12345678 to restore the backup files.

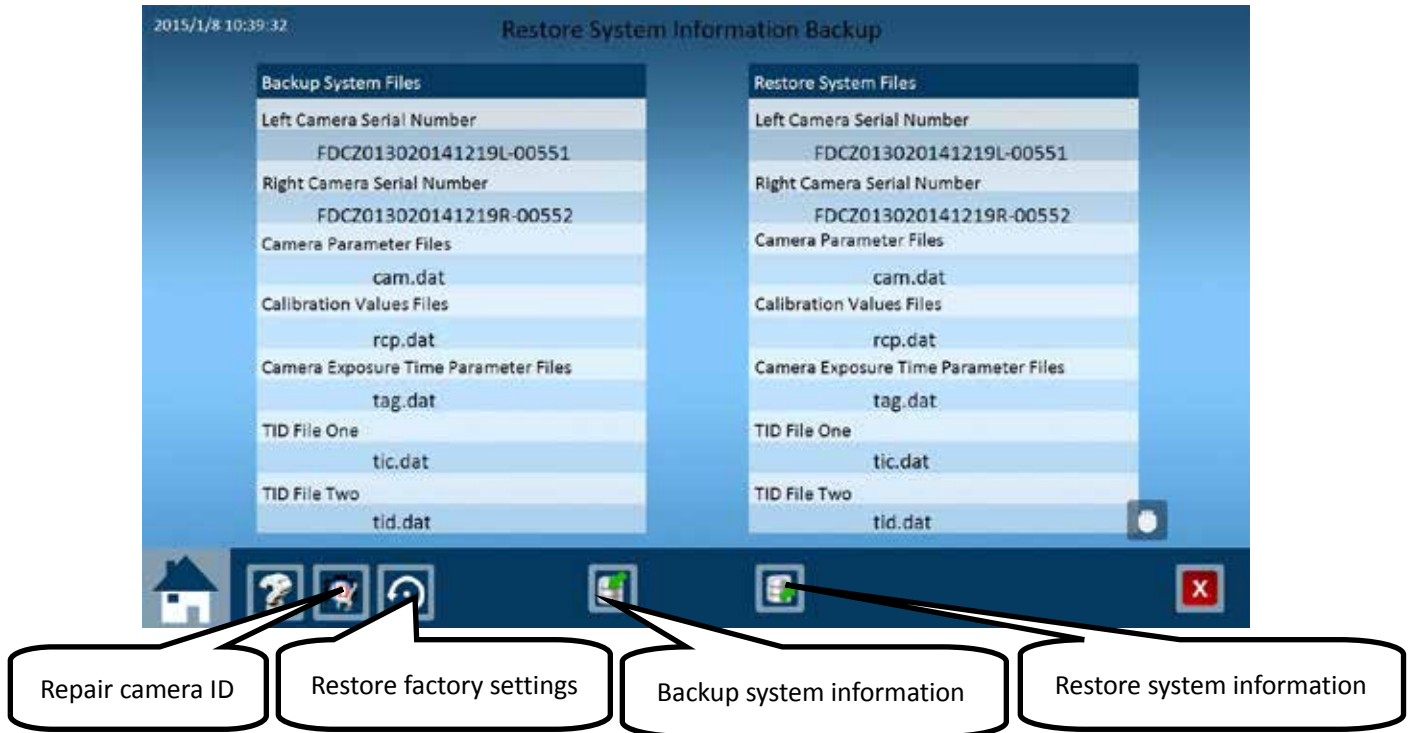

Repair camera ID: when the ID of cameras are broken, system will indicate “the RCP file doesn’t match camera ID, and the “repair camera ID” button will flickering in red and white color. Customer can click button to repair the camera ID automatically if doesn’t change the new cameras.

Restore factory settings: restore the camera gain, exposure time and other information that set in the factory.

8.1.5 Relevant information

Relevant information include: equipment information, register information and customer information.



8.1.5.1 Equipment information

Equipment information display the current equipment's camera ID, hardware ID and software version and driver version.



8.1.5.2 Register Information

Register information display the uses-permission and valid date.

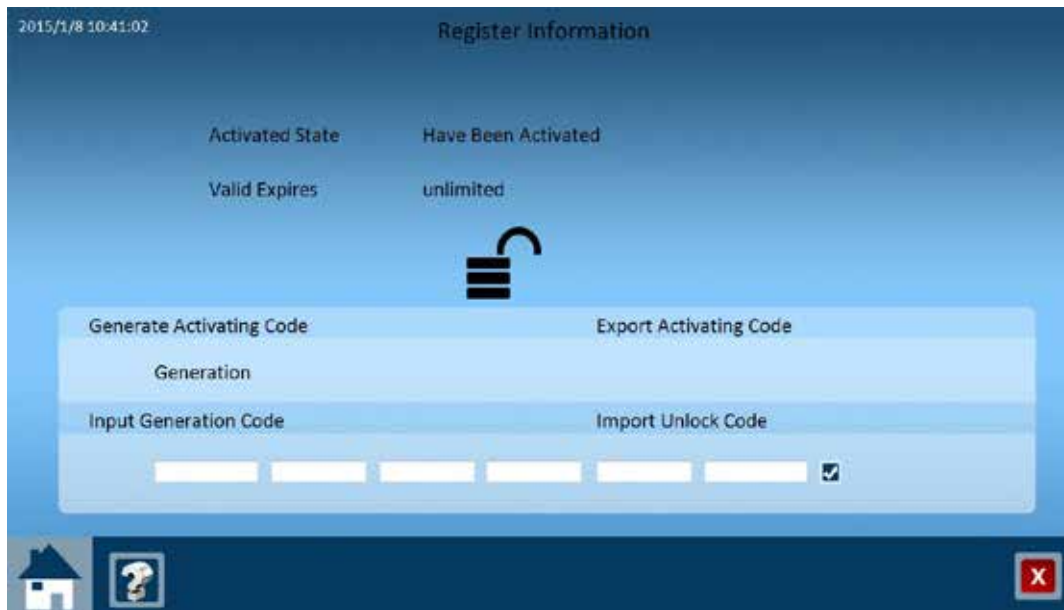

Activated state: the uses-permission of the customer.

Using expires: display the next expires date. If display “unlimited” means the equipment unlock forever.

Generate activating code: it will generate a serial codes when using date expired .

Import unlock code: the unlock code can import as TXT file.

Input generating code: the operator input this code will unlock the equipment.

8.1.5.3 Customer information

Customer can add LOGO and their information on homepage and printout page.



8.2 Camera calibration

Click “camera calibration” on “system maintenance” screen can enter camera calibration screen. It includes: RCP (double camera calibration), RCP verification, TID and distance measurement target calibration. The password is 12345678.

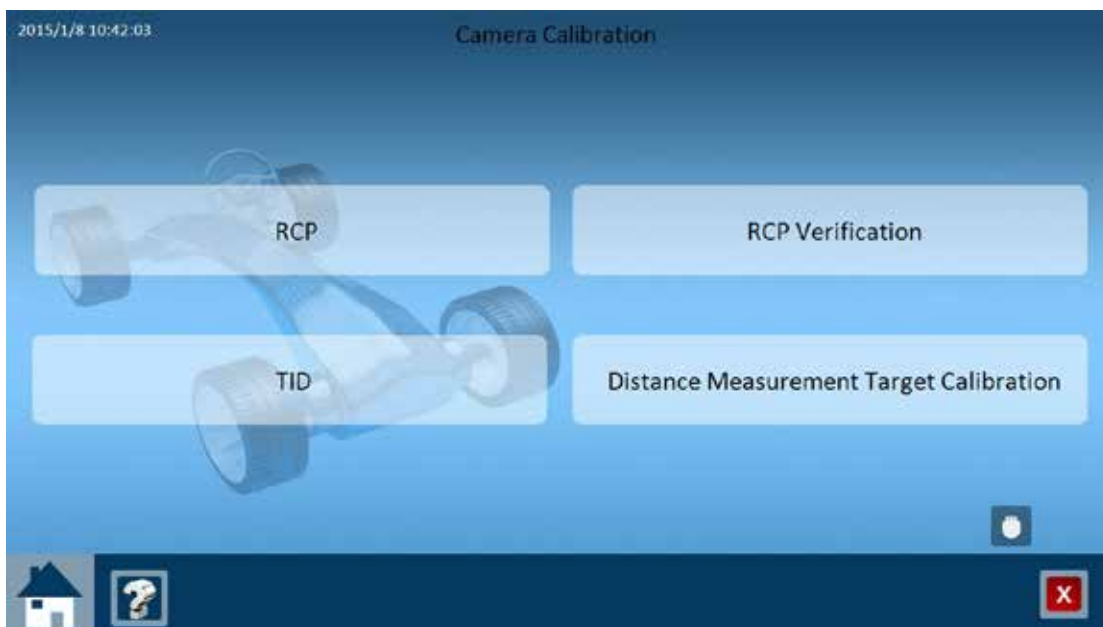

8.2.1 RCP

RCP is one of the ways to calibrate the relationship between left camera and right camera. The customer need to purchase special 3D calibration bar from factory if want to do RCP of wheel alignment.

Calibration bar installation:

Screw the M6 set screws in the calibration bar, move the calibration bases from two sides, use inner set screws to locate, then screw in the set screws to locate the calibration base, at last, screw the M8 knobs to the corresponding position. See below photo for reference.



8.2.1.1 Confirm the targets position

1. Operator must trace the targets to confirm the targets position. Use rear targets as calibration target. So put the calibration bar with two rear targets on 1m position behind the center of turntable, the center of the targets must be parallel with camera beam, also the targets must be vertical to the ground, then lock the calibration bar tightly. Can click animation help for reference.
2. Operator can choose close “automatic exposure time calculation” during calibration procedure, and change as adjust the gray values of

targets manually. Operator can choose this option when the light environment has large change.

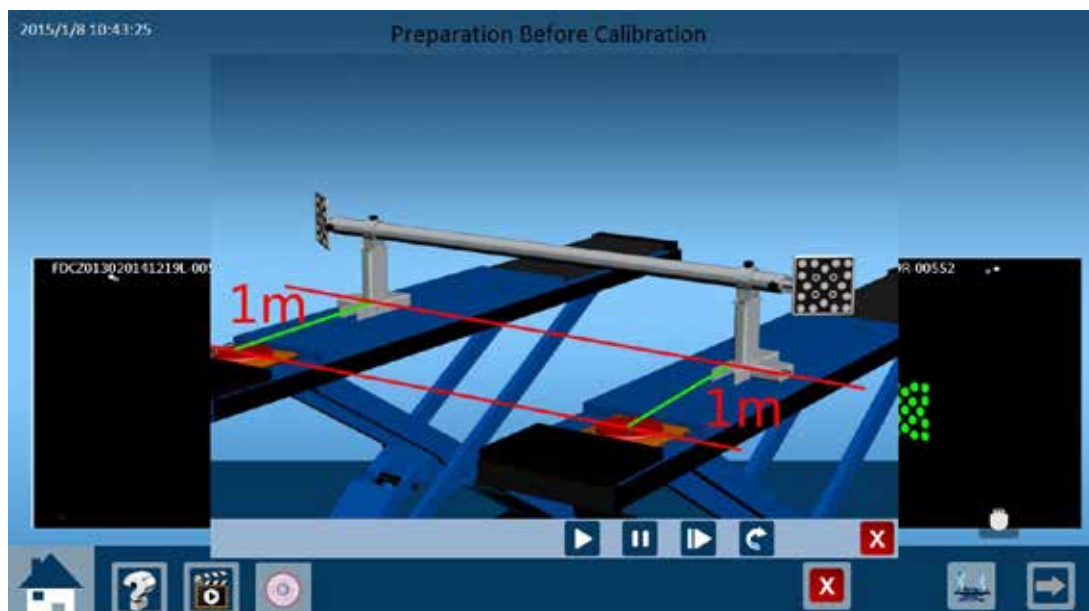
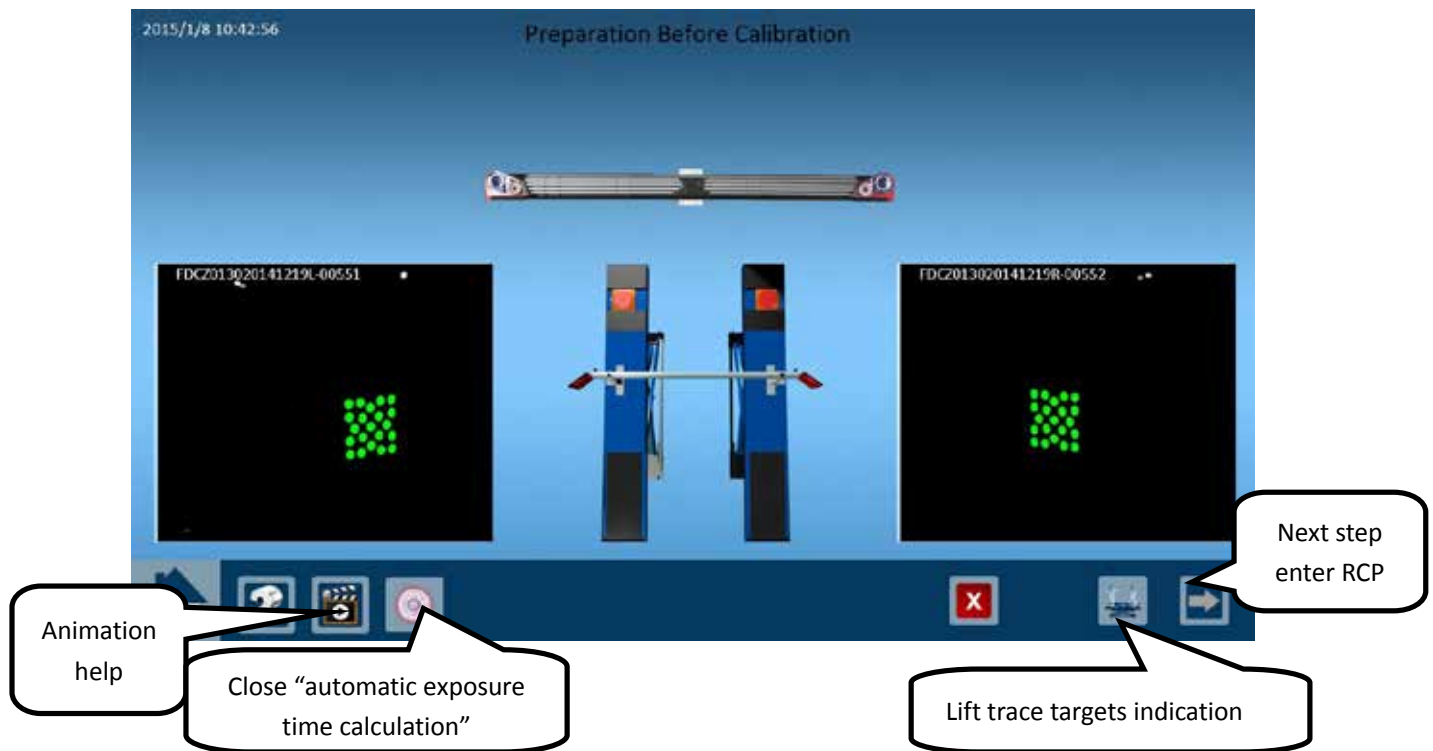

animation indication of calibration bar position

Fixed version 3D alignment must adjust lift height to be suitable for the targets view field in the camera, make sure the targets display on the software screen are in green color.

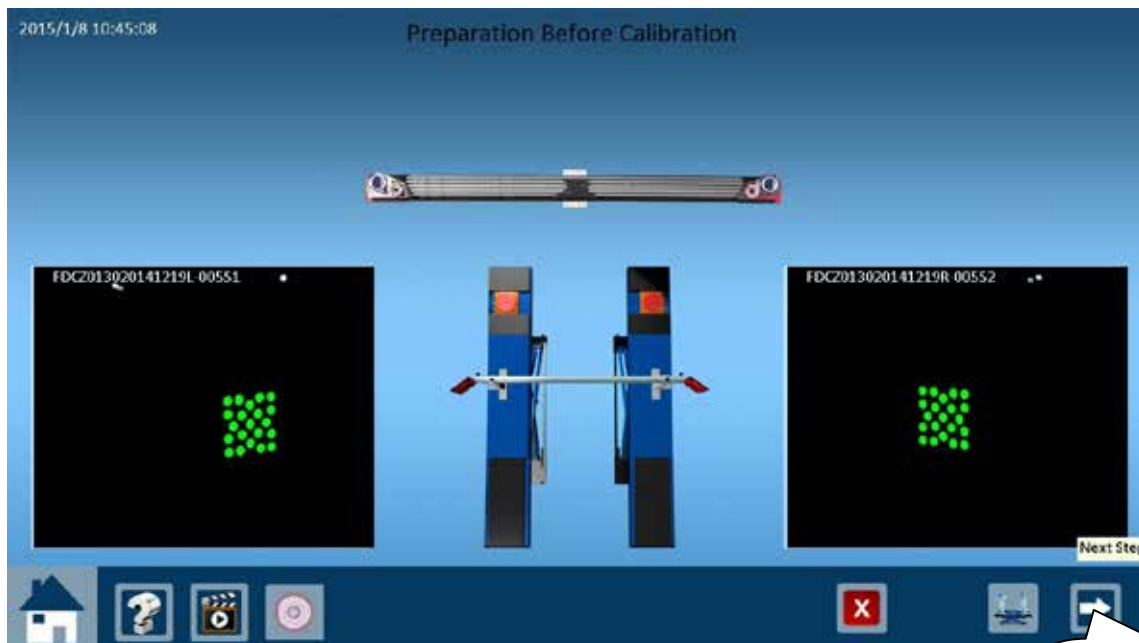
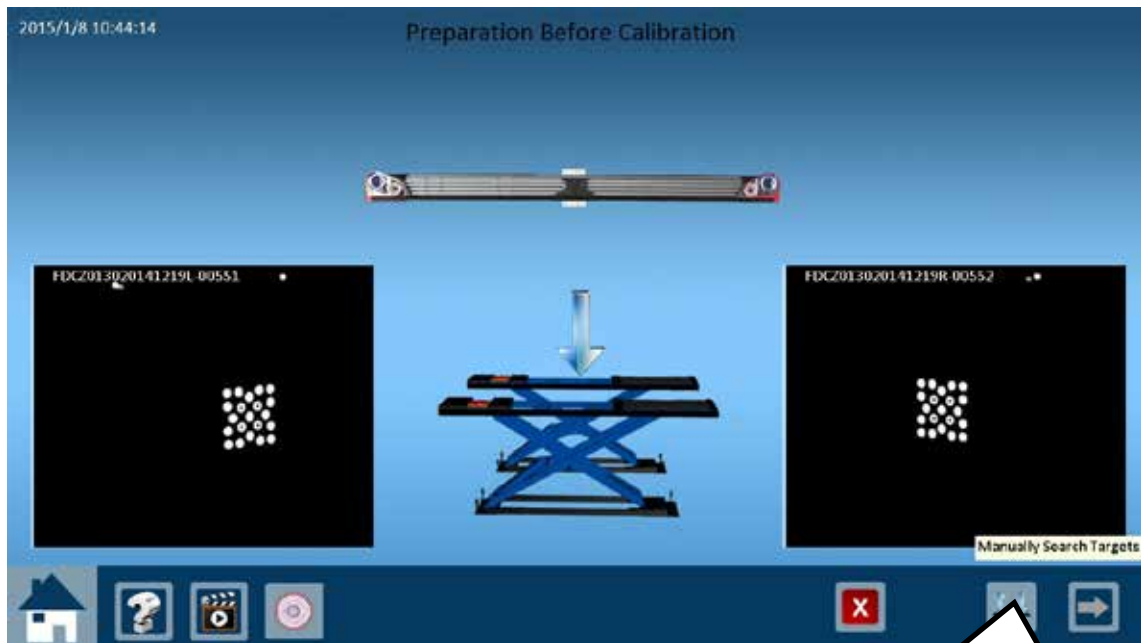

When the “next button” color from gray to white means targets trace finished, can continue to next step.

Automatic version 3D alignment can click “trace targets automatically” button to let the system adjust the targets view field position automatically, or click “trace targets manually” button to choose keyboard or press key to adjust camera beam height to adjust the targets view field position.

8.2.1.2 Calibration step 1

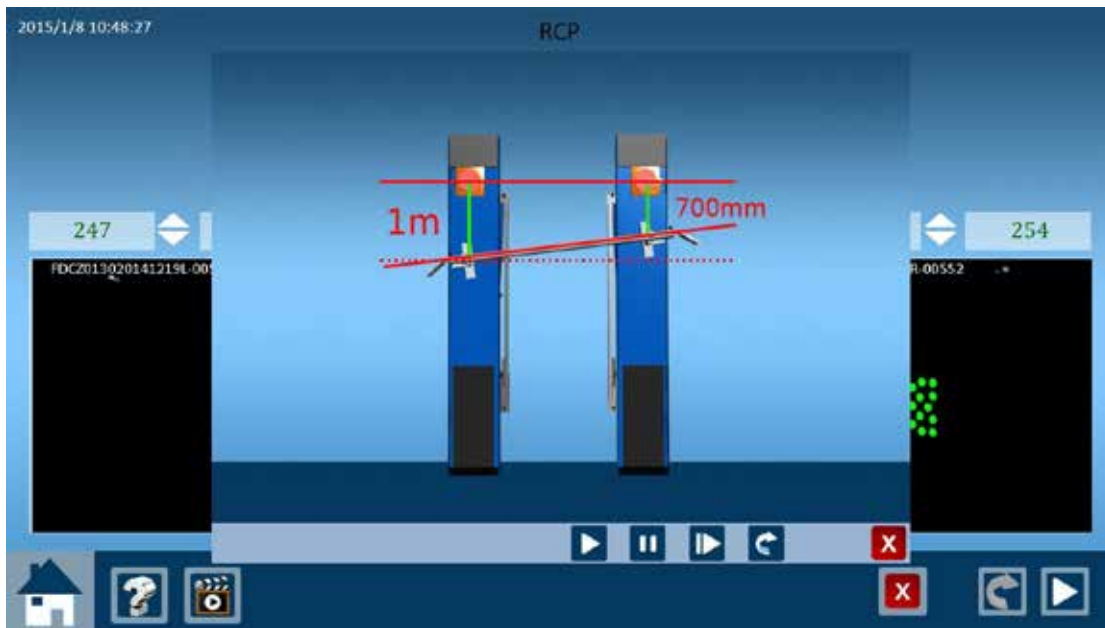

After trace targets successfully, enter next step to “RCP” screen. Operator need to move the right side of calibration bar forward about 300mm, left side keep the original position. Make sure the two targets on the calibration bar are vertical to the ground, and prepare to calibrate.

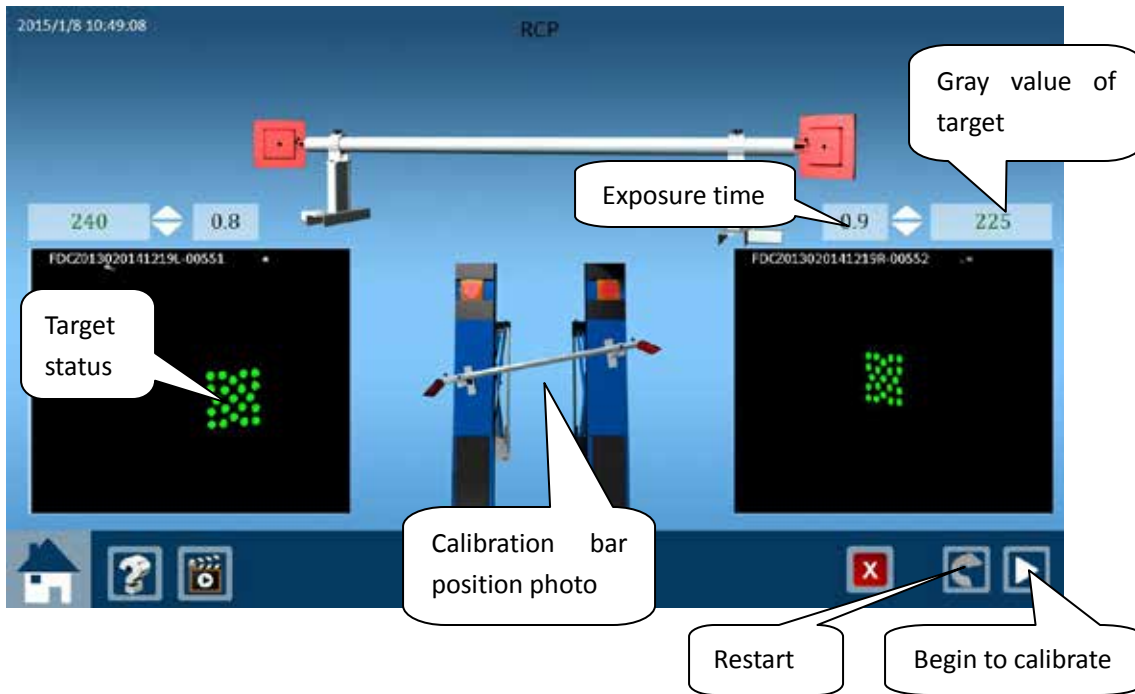

If the gray value of targets out of standard range, operator can change the gray value of targets through adjust exposure time!!

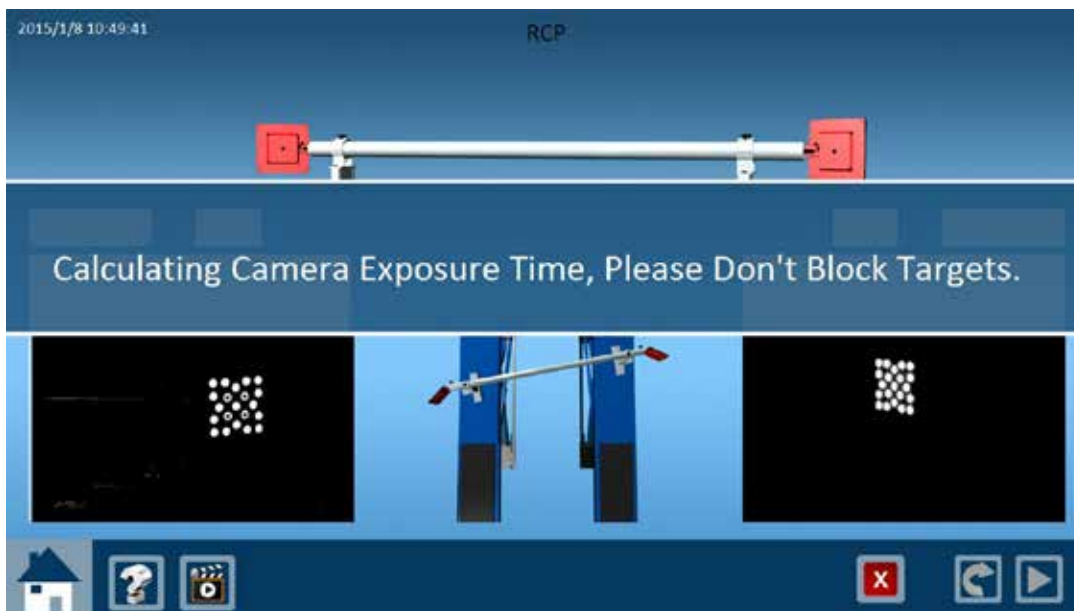

Click “begin to calibrate” button, the indication “calculating camera exposure time, please don’t block targets” appears on the screen.

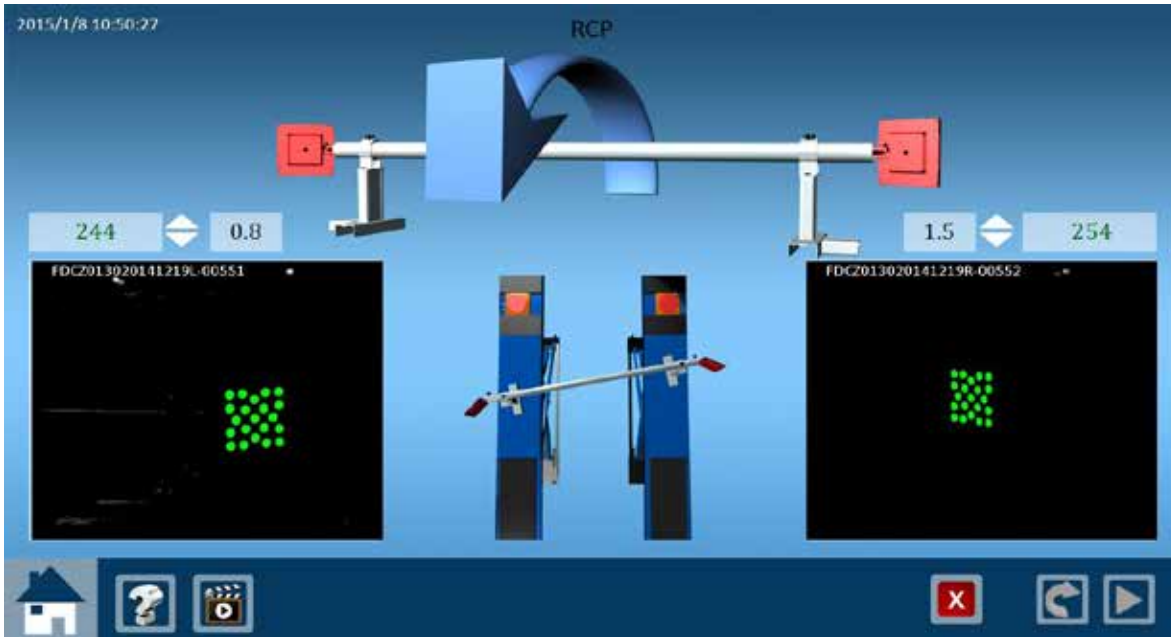

Turn the calibration beam slowly to the vehicle tail direction according to the animation indication.

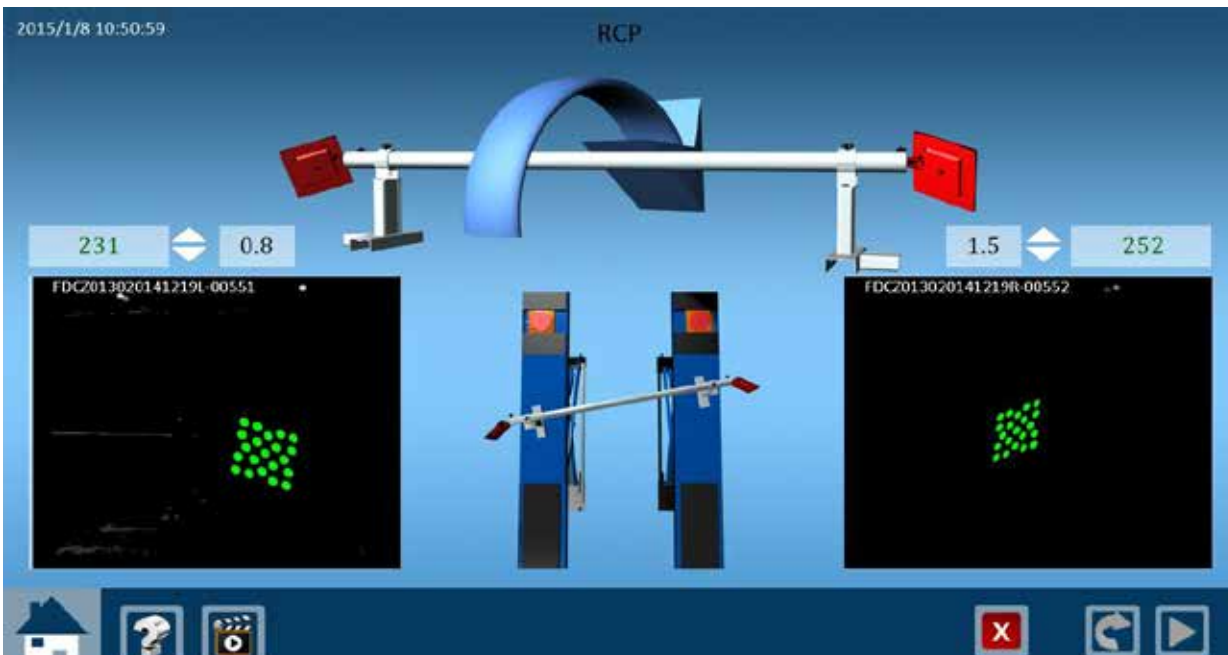

Turn the calibration beam slowly to the vehicle head direction when the arrow animation on the screen to vehicle head direction.

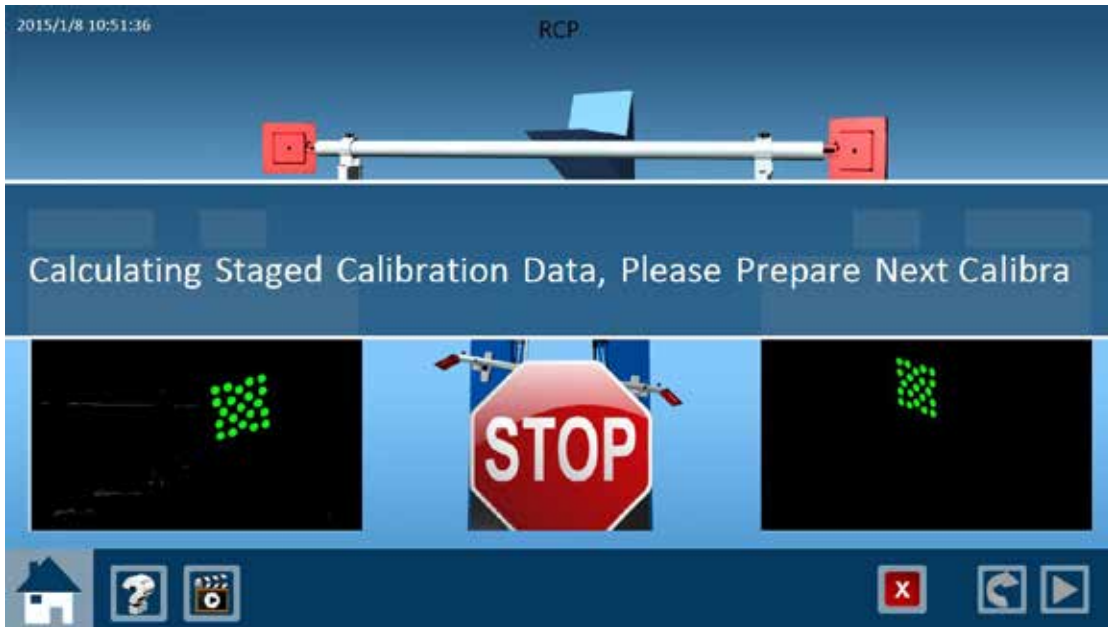

Turn calibration beam to head direction till the screen appear STOP and stop turning. The screen will indicate “calculating staged calibration data, please prepare next calibration”, at this time, operator can move the calibration bar to prepare the next calibration step.

8.2.1.3 Calibration step 2

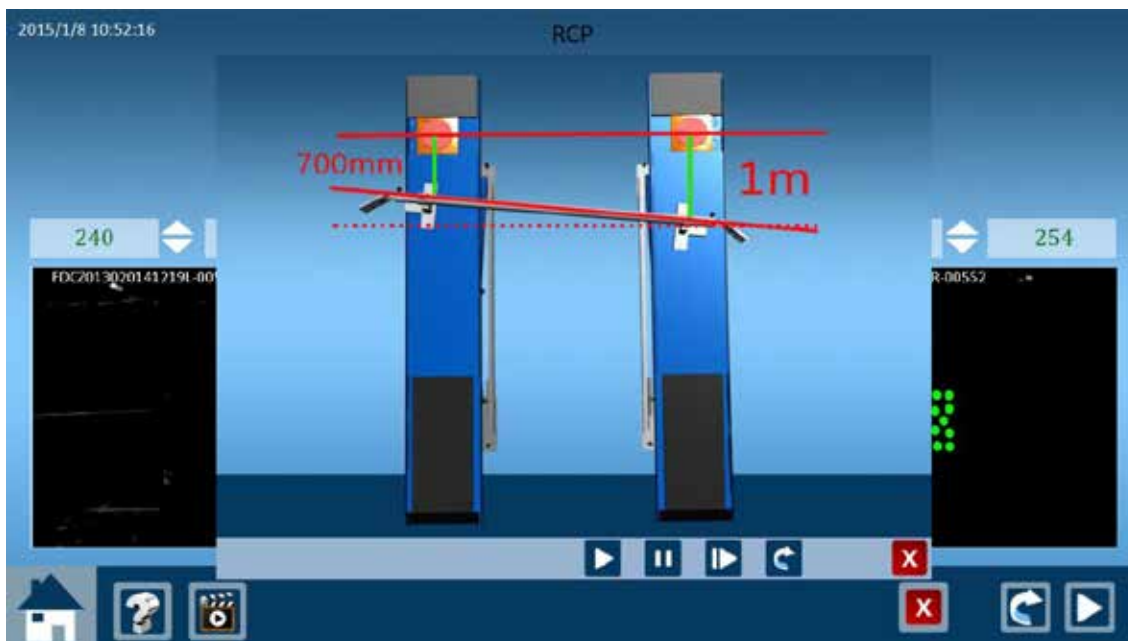

After calibration step 1 finished, operator need to move the right side of calibration bar backward about 300mm, back to original 1m position,

and then move the left side of calibration bar forward about 300mm. Make sure the two targets on the calibration bar are vertical to the ground, and prepare to calibrate.

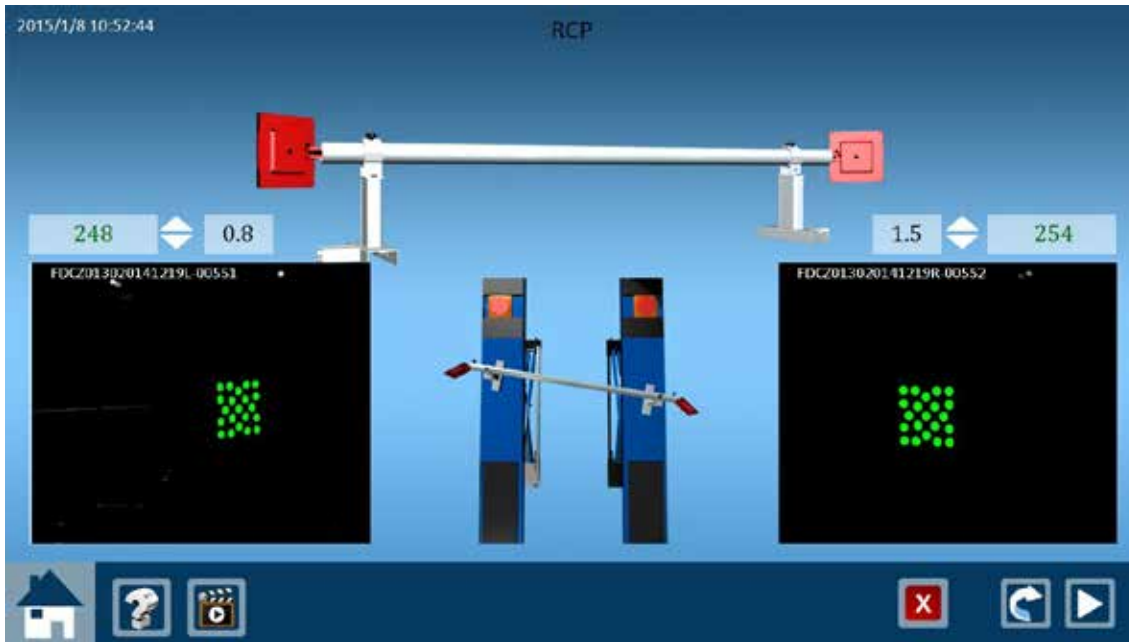

Click next step to begin second step calibration.

If the gray value of targets out of standard range, operator can change the gray value of targets through adjust exposure time!!



Click "begin to calibrate" button, the indication "calculating camera exposure time, please don't block targets" appears on the screen.

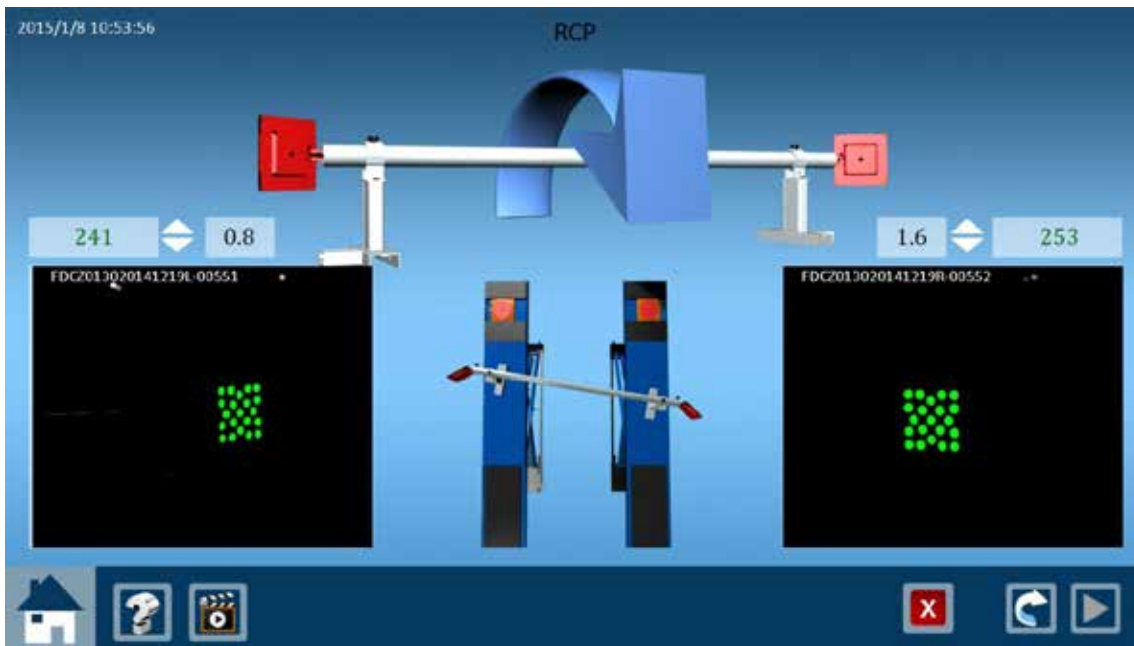

Turn the calibration beam slowly to the vehicle tail direction according to the animation indication.

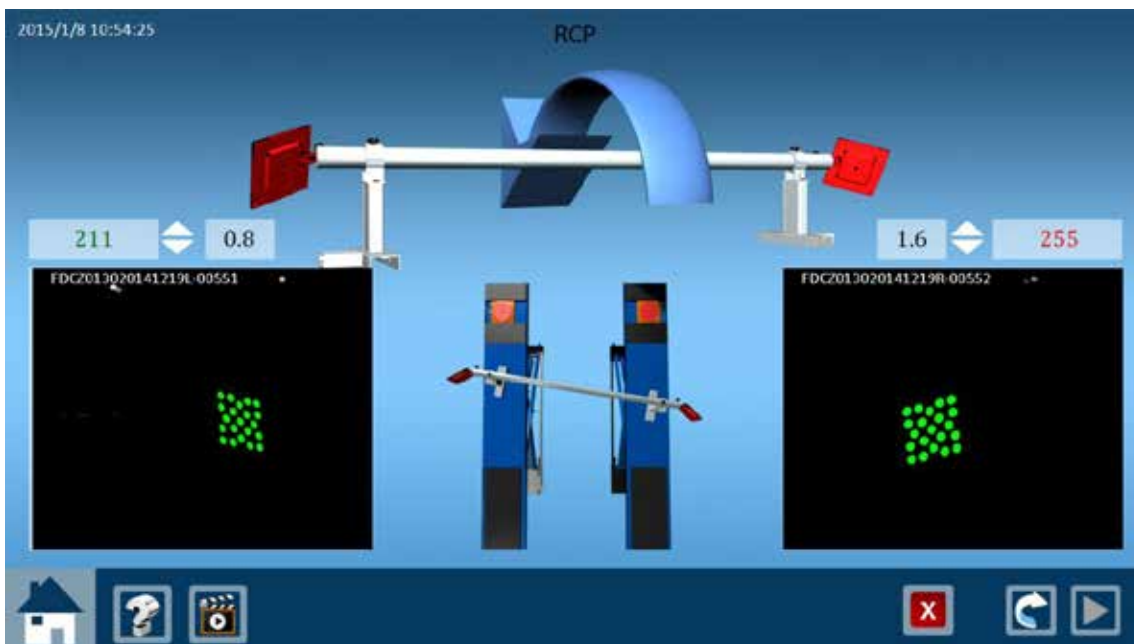

Turn the calibration beam slowly to the vehicle head direction when the arrow animation on the screen to vehicle head direction. When the screen appears STOP, the operator must stop turning the calibration beam.

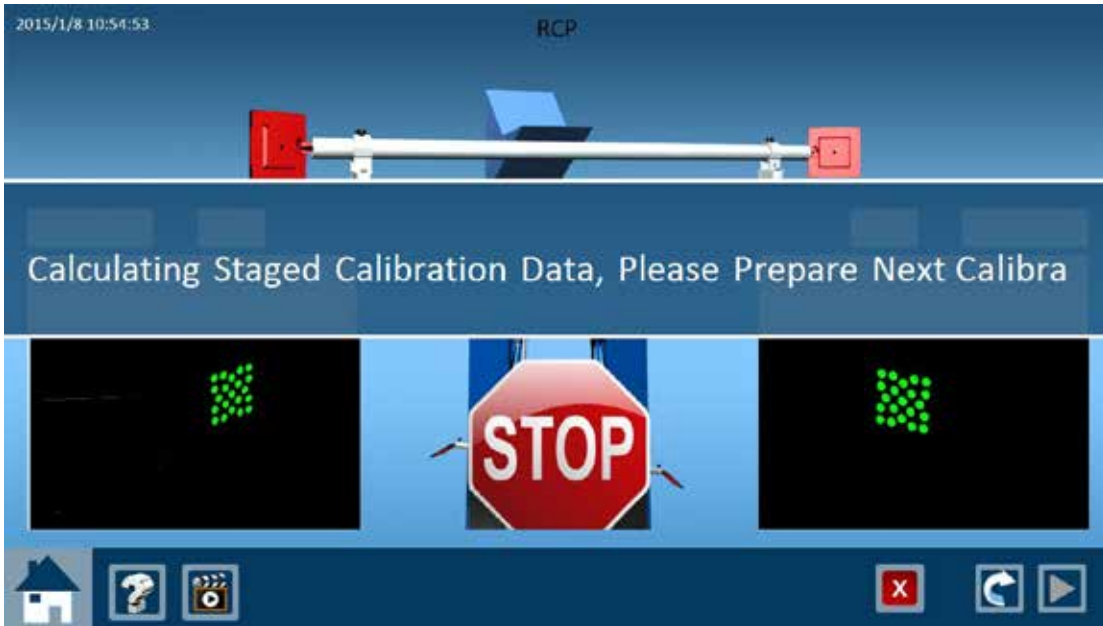

Turn calibration beam to head direction till the screen appear STOP and stop turning. The screen will indicate “calculating staged calibration data, please prepare next calibration”, at this time, operator can move the calibration bar to prepare the next calibration step.

8.2.1.4 Calibration step 3

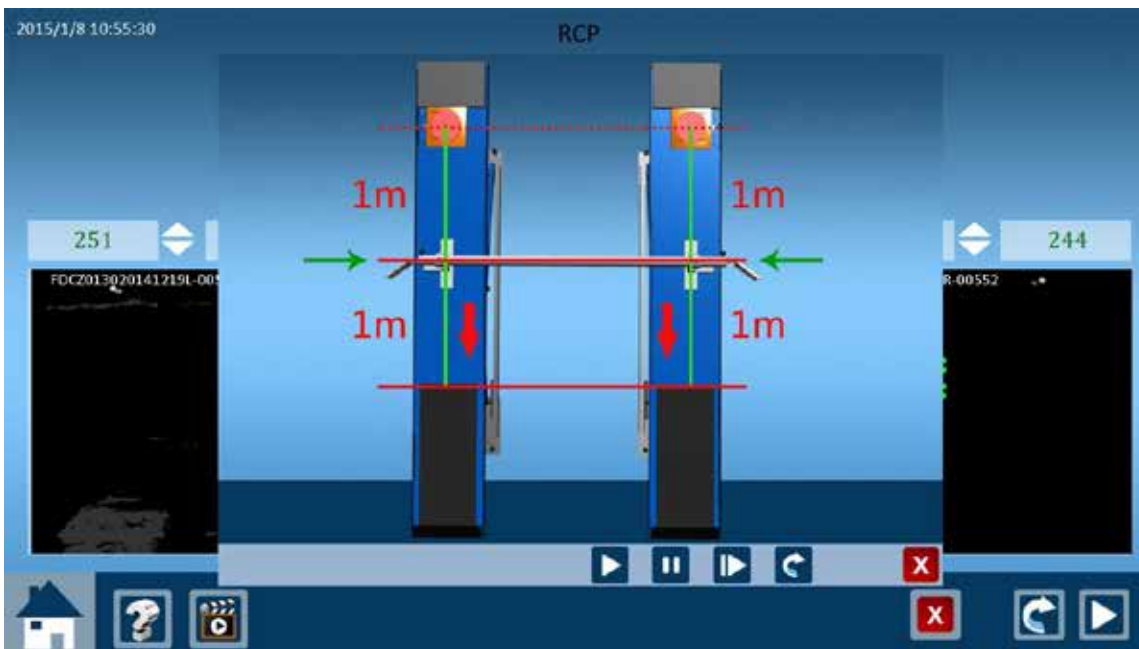

After calibration step 2 finished, move the calibration bar backward about 1m, so the distance from calibration bar to turntables is about 2m.

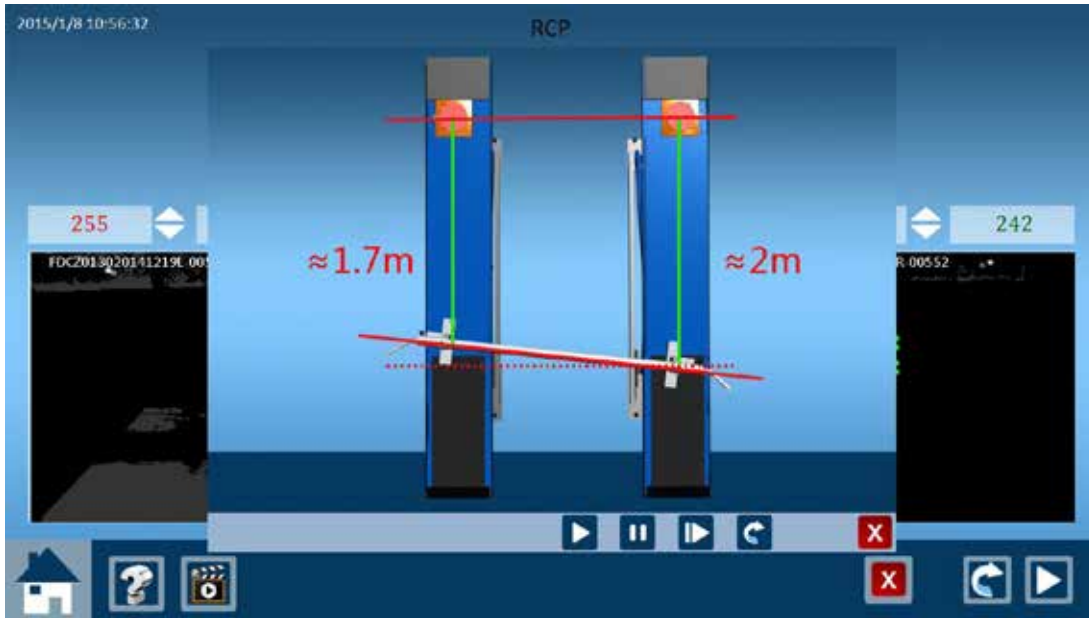

Operator need to move the right side of calibration bar forward about 300mm, left side keep the original position. Make sure the two targets on the calibration bar are vertical to the ground, and prepare to calibrate.

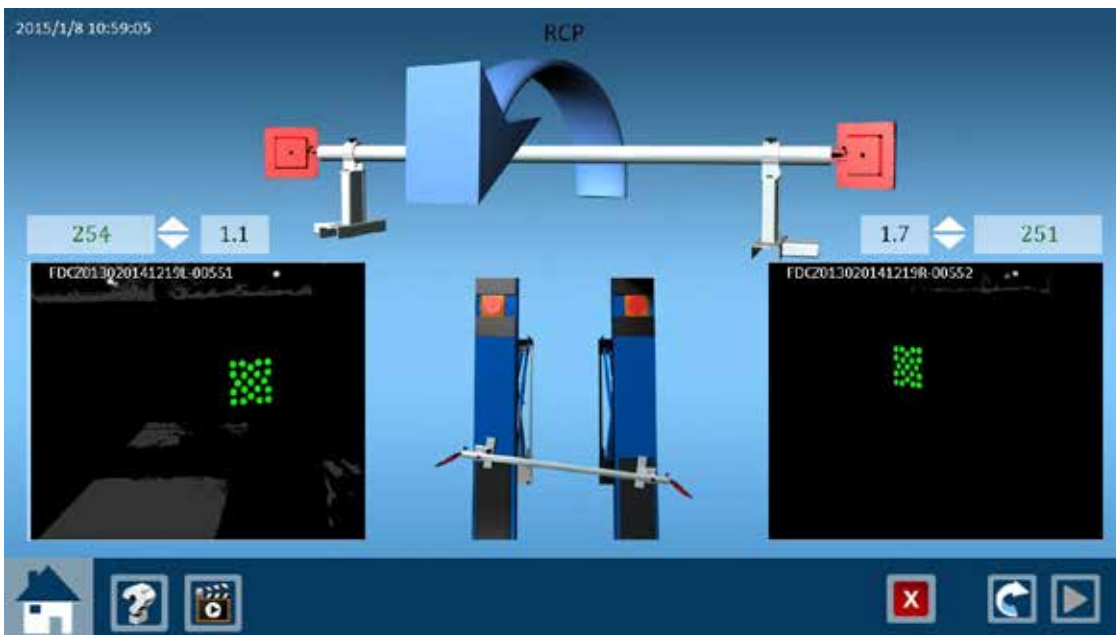

Click begin button, then turn the calibration beam slowly to the vehicle tail direction according to the animation indication.

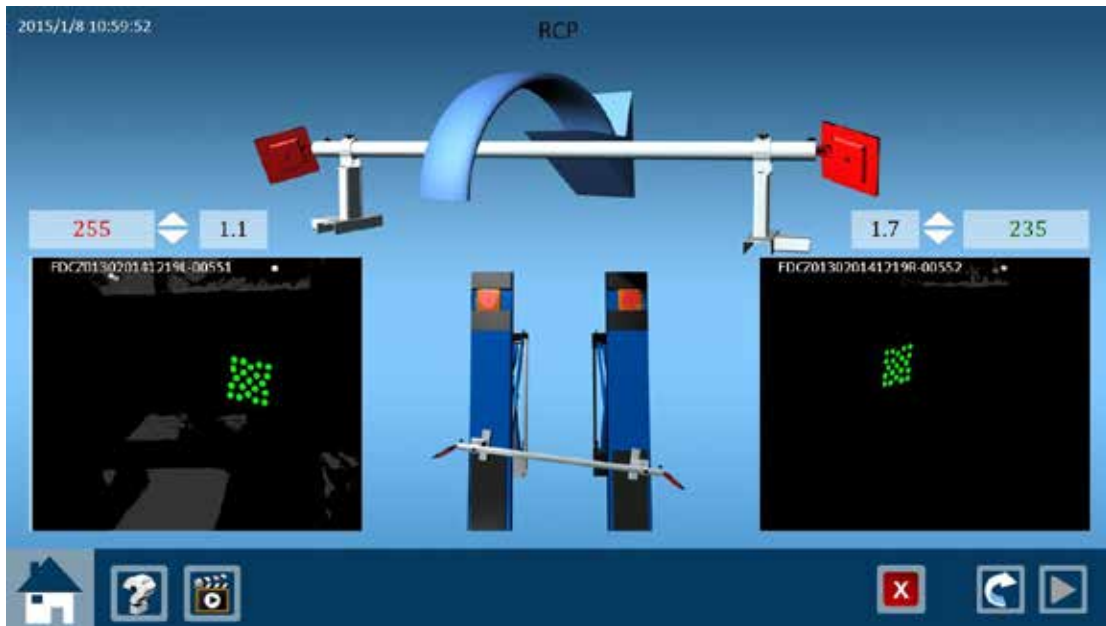

Turn the calibration beam slowly to the vehicle head direction when the arrow animation on the screen to vehicle head direction. When the screen appears STOP, the operator must stop turning the calibration beam.



Turn calibration beam to head direction till the screen appear STOP and stop turning. The screen will indicate “calculating staged calibration data, please prepare next calibration”, at this time, operator can move the calibration bar to prepare the next calibration step.

8.2.1.5 Calibration step 4

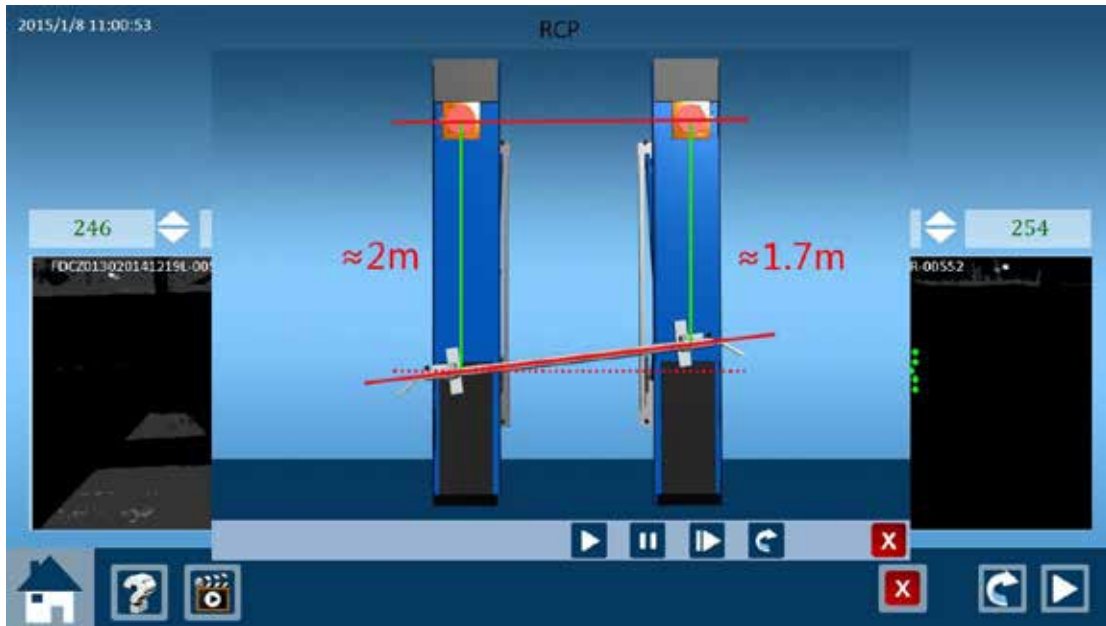

After calibration step 3 finished, operator need to move the right side of calibration bar backward about 300mm, back to original 1m position, and then move the left side of calibration bar forward about 300mm. Make sure the two targets on the calibration bar are vertical to the ground, and prepare to calibrate.

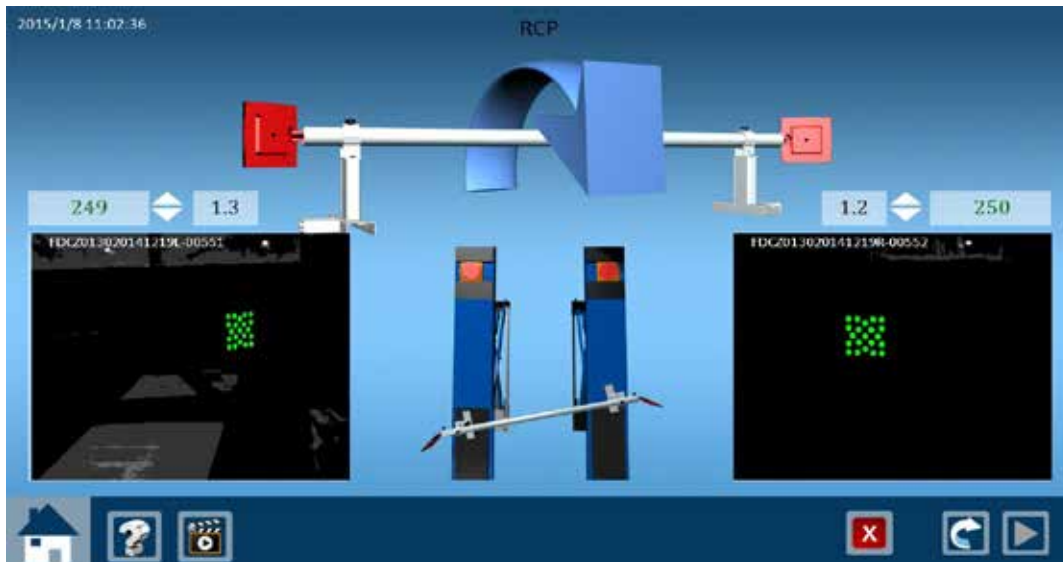

Turn the calibration beam slowly to the vehicle tail direction according to the animation indication.

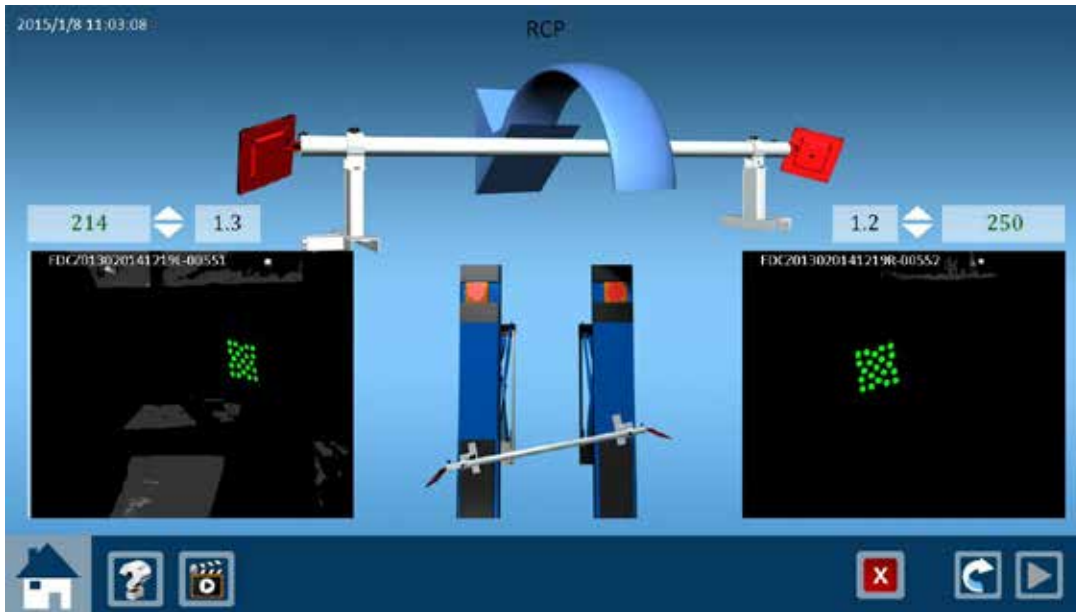

Turn the calibration beam slowly to the vehicle head direction when the arrow animation on the screen to vehicle head direction. When the screen appears STOP, the operator must stop turning the calibration beam.

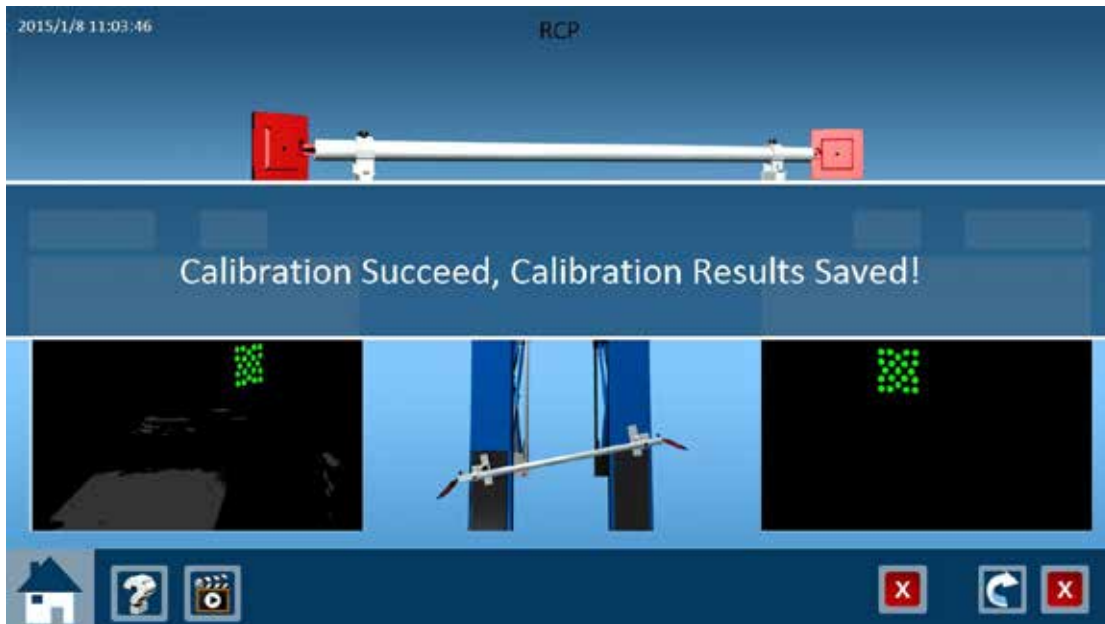

After calibration step 4 finished, the screen appears “calibration succeed, calibration results saved!”

8.2.2 TID

Our 3D alignment products use the real time TID calculation technology during the measurement, so the customer doesn't need to do TID after equipment installation. But it must make once TID if the customer wants to choose "super measurement" way.

It needs to install the clamps with targets together after equipment installation, also use tool to fix the clamps and targets. Then clamp the four clamps with targets on the four wheels tightly, make sure the claws of the clamps stick to rim of the wheel very closely. Run wheel alignment software program, choose "TID" on camera calibration screen.

NOTE:

1. Make sure the claw of the clamp must stick to the rim of the wheel very closely and tightly. Because it is the important element to guarantee the precise measurement.
2. If the customer chooses the "super measurement" function, it must make once TID after equipment installation, make sure the clamps with targets always fix together after TID. It needs to make TID again if the clamps and targets separate, or will affect the measurement precision. Other measurement ways don't need to do TID, also clamps and targets can separate.



Click "TID" located on the left side of the screen, and then enter TID.

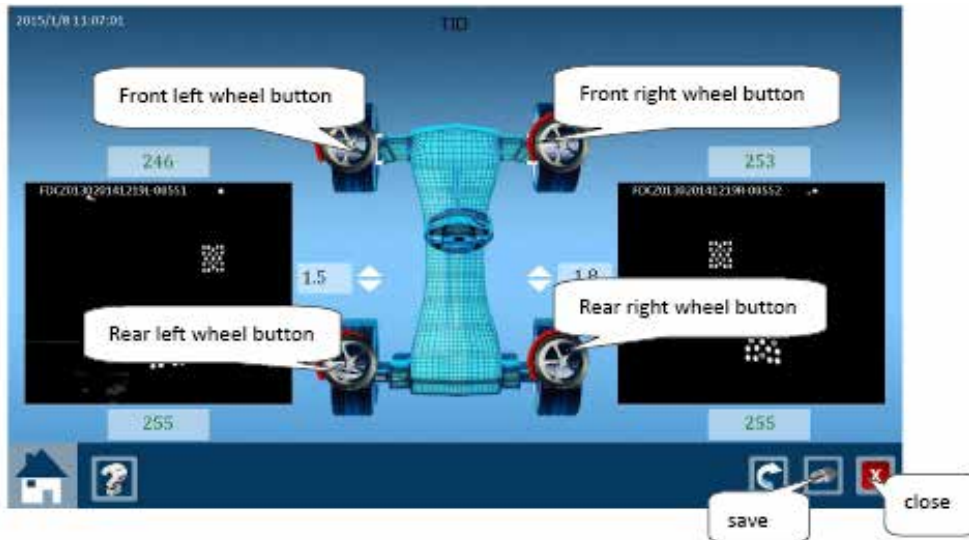

The TID screen will show and now the operator can click on any of the wheels to begin doing TID.



For example, if you choose the front left wheel, click the front left wheel button and the system will indicate “calculating camera exposure time, please don’t block targets”.

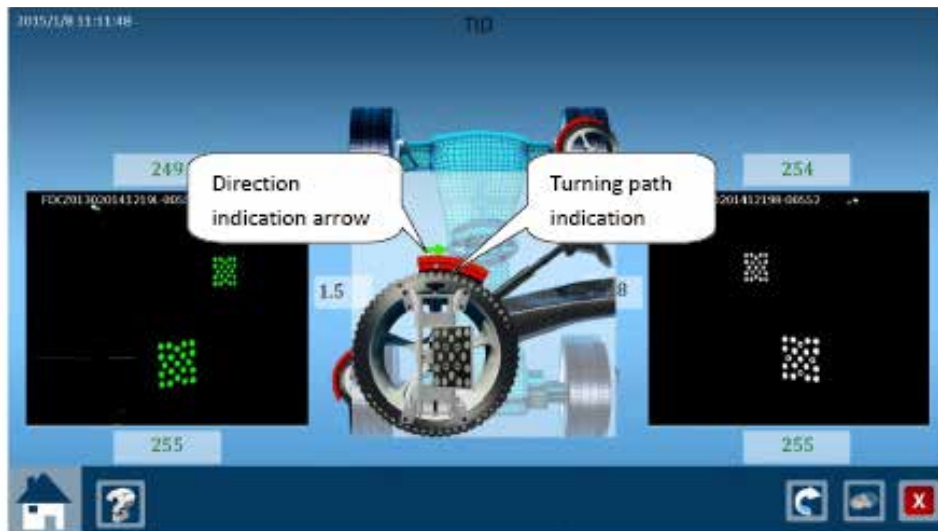

Operator must turn the wheel slowly to the vehicle tail direction according to arrow indication and turning path indication on the screen.

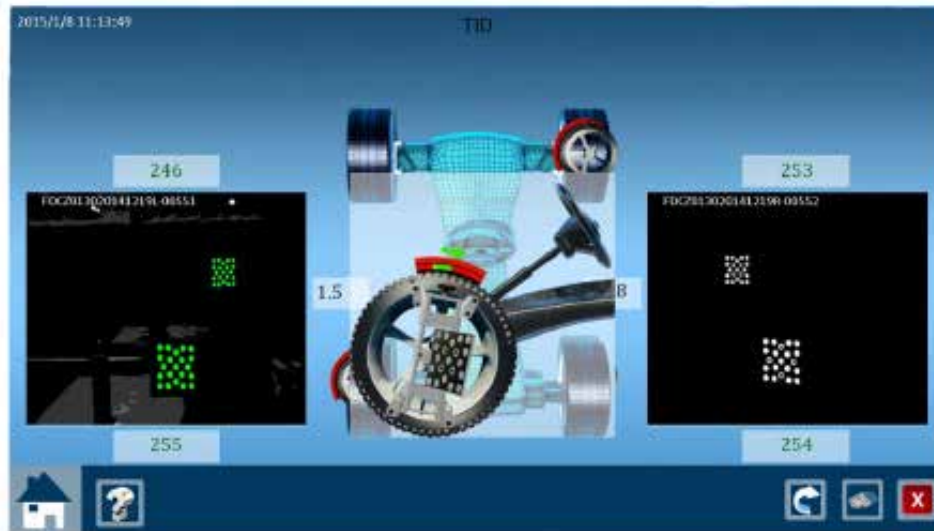

Wheel turning procedure.

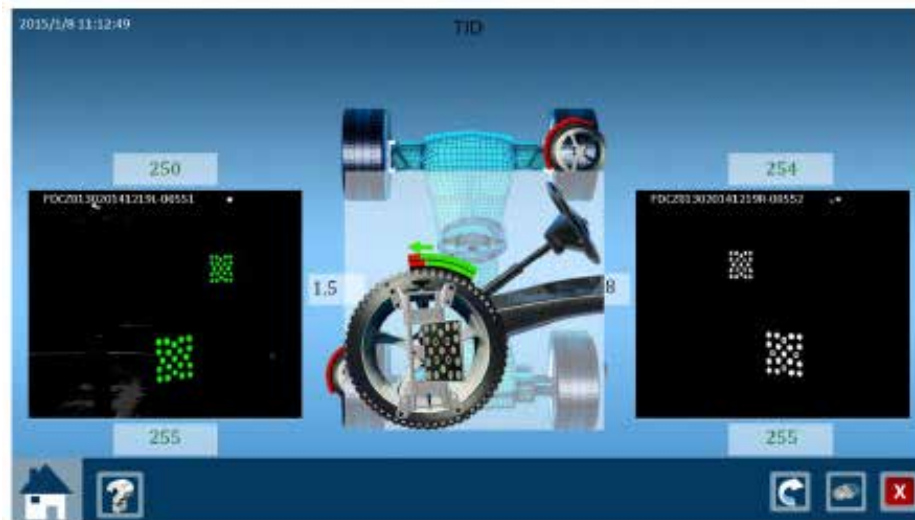

When STOP, appears on the screen, stop turning and turn the wheel to the opposite direction according to the arrow indication.

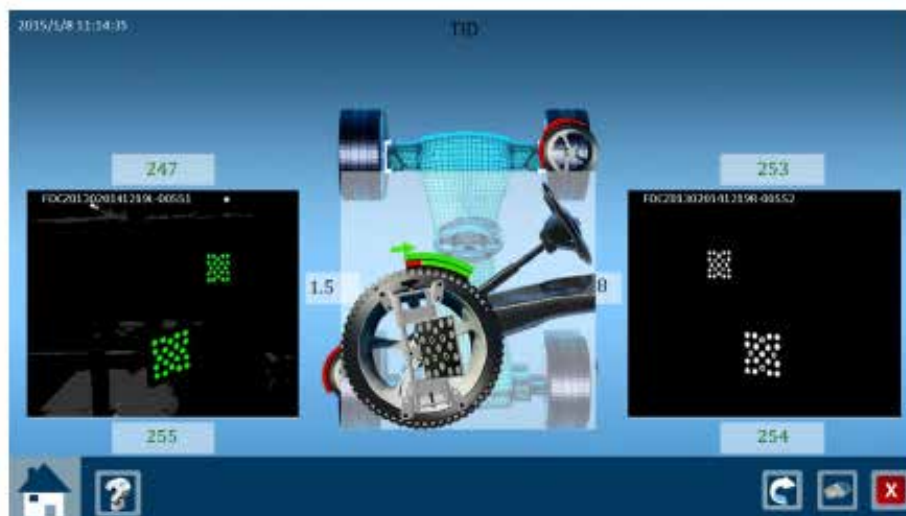

When you see STOP, stop turning and turn the wheel to the opposite direction according to the arrow indication.

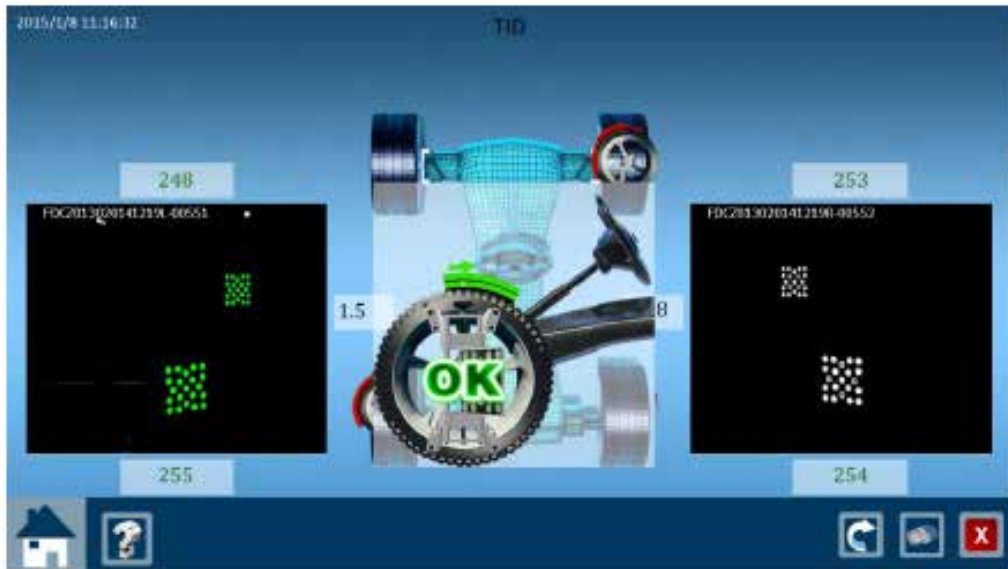

Turn to the original position, the screen will show OK, stop turning and finish the front left wheel TID. Continue doing the other three wheels TID procedure the same way as you did the front right wheel.

8.3 Camera View

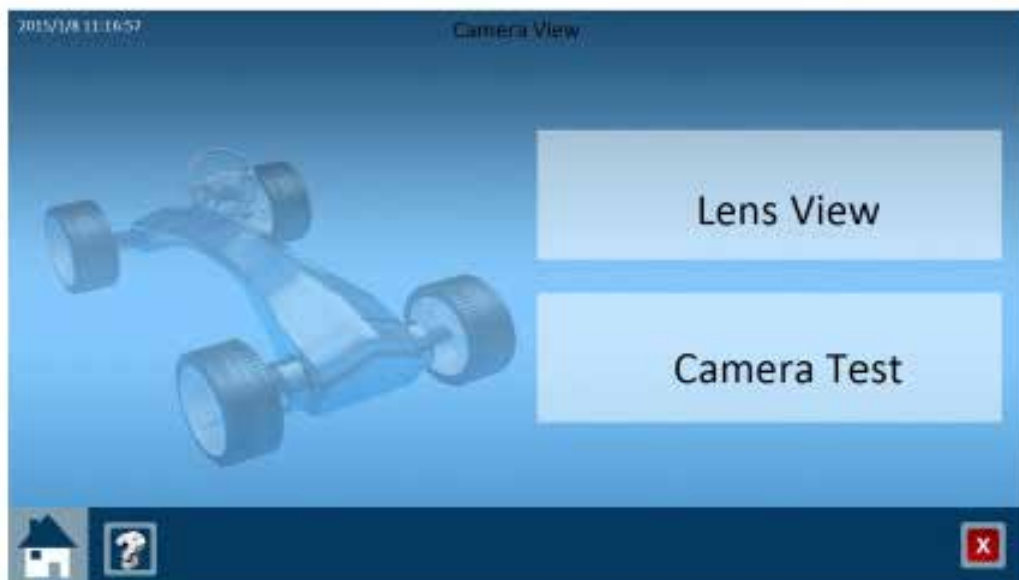

Lens view screen displays the original images of targets in color, here you can also test the left and right camera's lens view range. (See next image).

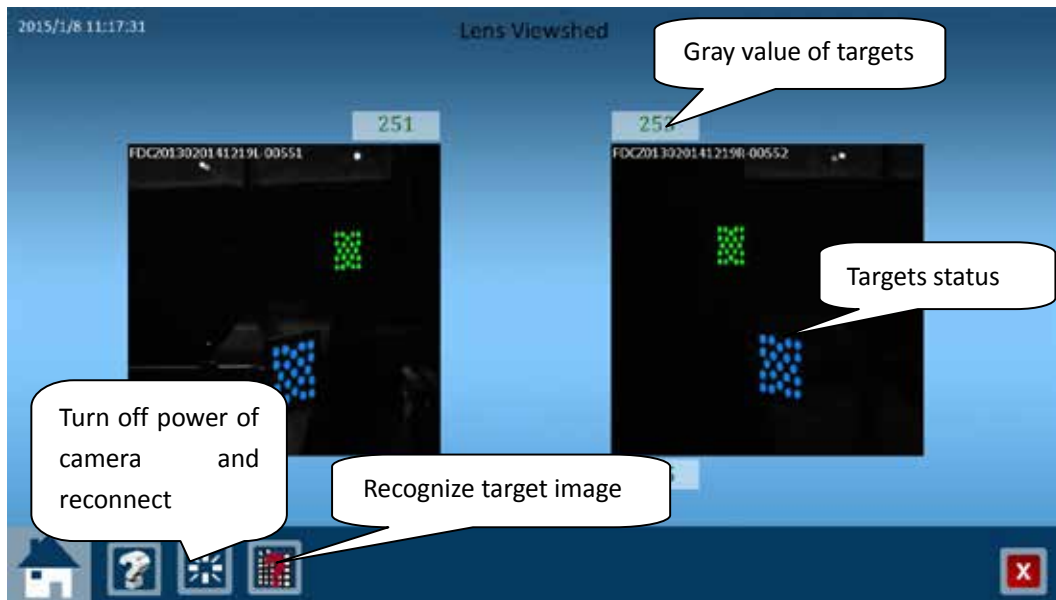

8.3.2 Camera Test

This function serves mainly to test and adjust the image effect, gray value range of front and rear targets, and also to adjust LED brightness.

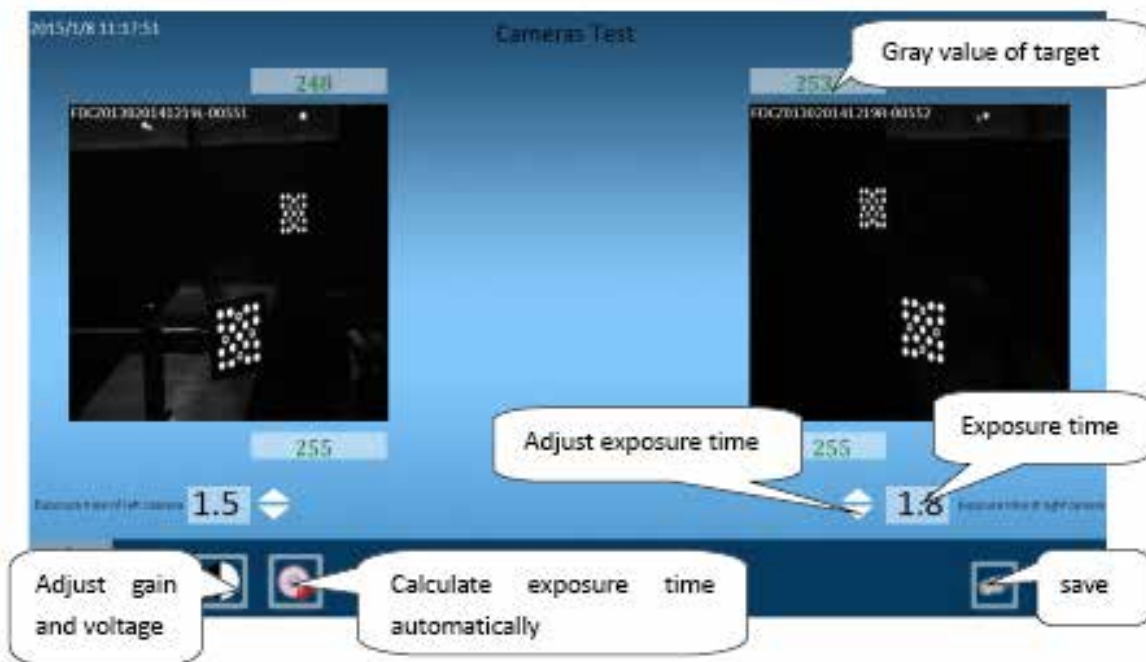

Gain Adjustment: Adjusts the light sensitivity of camera chip.

Exposure Time Adjustment: The measurement precision maybe affected if the working environment lighting is too bright or too dark due to the dots of targets brightness will change. Operator can adjust targets image brightness by adjusting exposure time. Also, can click “calculate exposure time automatically” to adjust automatically.

Gray Value: Represents the brightness of targets. System requires the brightness range is 210-255.

Led Board Voltage: Operator can adjust LED brightness by adjusting the voltage of LED.

8.4 Add Vehicle Specification from Wheel Alignment Data Book

Identification	Ref. No		
	Model (body code)		
	Version Year		
Dimensions	Wheelbase	mm	
	Track - front/rear	mm	
Tightening Torques	Steel road wheels	Nm	
	Alloy road wheels	Nm	
	Track rod locknut/clamp	Nm	
Checking Range Front wheels see important notes	Toe-in (N=Negative, toe-out)	mm degrees-min degrees-1/100	
	Camber	degrees-min degrees-1/100	
	Castor	degrees-min degrees-1/100	
Load Positioning	For load see table on last page	o = unladen	
	Fuel tank - percentage full	%	
	Ride height reference table		
Setting Data Front Wheels see important notes	Toe-in (N=Negative, toe-out)	mm degrees-min degrees-1/100	
	Camber	degrees-min degrees-1/100	
	Tolerance left/right	degrees-min(1/100) ■ = adjustable □ = non adjustable	
	Castor	degrees-min degrees-1/100	
	Tolerance left/right	degrees-min(1/100) ■ = adjustable □ = non adjustable	
	KPI (SAI)	degrees-min degrees-1/100	
	included angle	degrees-min degrees-min(1/100)	
	Toe-out on turns at 20°	degrees-min degrees-min(1/100)	
	Lock angles, max. inner	degrees-min degrees-min(1/100)	
	Lock angles, max. outer	degrees-min degrees-min(1/100)	
	Setting Data Rear Wheels see important notes	Toe-in (N=Negative, toe-out)	mm degrees-min degrees-1/100 ■ = adjustable □ = non adjustable
		Camber	degrees-min degrees-1/100
		Tolerance left/right	degrees-min(1/100) ■ = adjustable □ = non adjustable

ALFA ROMEO

24648	20717	21890	20720	20722	21891
166	166	166	166	166	166
2,5/3,0 V6 Sport	3,0 V6 →VIN 22265	3,0 V6 MT VIN 22266→	3,0 V6 VIN 28534→	3,0 V6 →VIN 22265	3,0 V6 AT VIN 22266→
1999-05	MT 1998-99	VIN 28533 1999-00	MT 1999-05	AT 1998-99	VIN 28533 1999-00
2700	2700	2700	2700	2700	2700
1545/1532	1545/1532	1545/1532	1545/1532	1545/1532	1545/1532
93 Nm	93 Nm	93 Nm	93 Nm	93 Nm	93 Nm
86 Nm	86 Nm	86 Nm	86 Nm	86 Nm	86 Nm
-	-	-	-	-	-
1N-3N	3N-5N	1N-3N	1N-3N	3N-5N	1N-3N
0°9'N-0°25'N	0°26'N-0°42'N	0°9'N-0°25'N	0°9'N-0°25'N	0°26'N-0°42'N	0°9'N-0°25'N
0,15N-0,42N	0,43N-0,70N	0,15N-0,42N	0,15N-0,42N	0,43N-0,70N	0,15N-0,42N
0°5'N-0°45'N	0°2'N-0°42'N	0°2'N-0°42'N	0°2'N-0°42'N	0°39'N-0°1'P	0°39'N-0°1'P
0,08N-0,75N	0,03N-0,70N	0,03N-0,70N	0,03N-0,70N	0,65N-0,02P	0,65N-0,02P
2°39'-3°39'	2°39'-3°39'	2°39'-3°39'	2°39'-3°39'	2°39'-3°39'	2°39'-3°39'
2,65-3,65	2,65-3,65	2,65-3,65	2,65-3,65	2,65-3,65	2,65-3,65
o	o	o	o	o	o
-	-	-	-	-	-
-	-	-	-	-	-
2N±1	4N±1	2N±1	2N±1	4N±1	2N±1
0°17'N±8'	0°34'N±8'	0°17'N±8'	0°17'N±8'	0°34'N±8'	0°17'N±8'
0,28N±0,13	0,57N±0,13	0,28N±0,13	0,28N±0,13	0,57N±0,13	0,28N±0,13
0°25'N±20'	0°22'N±20'	0°22'N±20'	0°22'N±20'	0°19'N±20'	0°19'N±20'
0,42±0,33	0,37N±0,33	0,37N±0,33	0,37N±0,33	0,32N±0,33	0,32N±0,33
-	-	-	-	-	-
□	□	□	□	□	□
3°9'±30'	3°9'±30'	3°9'±30'	3°9'±30'	3°9'±30'	3°9'±30'
3,15±0,50	3,15±0,50	3,15±0,50	3,15±0,50	3,15±0,50	3,15±0,50
-	-	-	-	-	-
□	□	□	□	□	□
-	-	-	-	-	-
-	-	-	-	-	-
-	-	-	-	-	-
-	-	-	-	-	-
-	-	-	-	-	-
-	-	-	-	-	-
-	-	-	-	-	-
-	-	-	-	-	-
-	-	-	-	-	-
-	-	-	-	-	-
-	-	-	-	-	-
3±1	5,50±1	3±1	3±1	5,50±1	3±1
0°25'±8'	0°45'±8'	0°25'±8'	0°25'±8'	0°45'±8'	0°25'±8'
0,42±0,13	0,75±0,13	0,42±0,13	0,42±0,13	0,75±0,13	0,42±0,13
2	2	2	2	2	2

8.4 Add Vehicle Specification from Wheel Alignment Data Book

We use the above vehicle specification information as an example to add vehicle specification to database.

Input the vehicle specification that software doesn't have. Click "Settings" on the homepage.



Click "Add vehicle specifications to database".

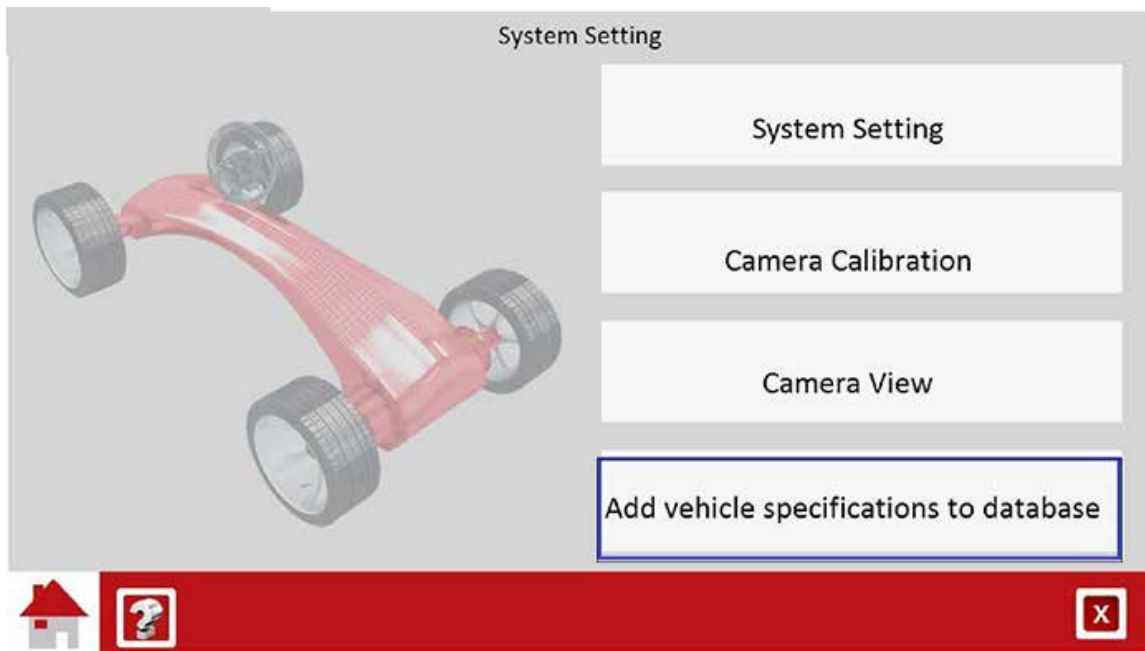



Input vehicle manufacturer, country, and logo or choose the vehicle manufacturer and the relevant country and logo populate automatically.

Customized vehicle database

1.Add vehicle manufacturer

Vehicle manufacturer

Country 

LOGO 



Click next step to input manufacture, model, first year and ending year according to example vehicle information. Other information is optional.

Customized vehicle database

2.Add vehicle model

Manufacturer

Model

First year

Ending year

Counter weight vehicle specs

Front left requested location of counter weight



Fuel capacity

Description



Add vehicle specification in the table. Per our example shown below, it is better to enter “input by Middle Values and also input Tolerance Values”.

Customized vehicle database

3.Add vehicle specifications to database

	Max	Middle Values	Min	
Single Toe				
Camber				
Caster				
KPI				
Included Angle				

	Max	Middle values	Min	
Single Toe				
Camber				

Input by max.value , min. Value, and middle value
 Input by middle value, tolerance value

Alfa Romeo 166

0-ACURA





Input vehicle specification as shown below.

Note: Middle Values must be entered with the symbol “-” if the specification number is negative. Tolerance Values DO NOT have to be input with the symbol “-” even if the specification is negative. After values have been input, press SAVE.

Customized vehicle database

3.Add vehicle specifications to database

		Middle Values		Tolerance values
Single Toe		-0.28		0.13
Camber		-0.42		0.33
Caster		3.15		0.50
KPI				
Included Angle				

		Middle values		Tolerance values
Single Toe		0.42		0.13
Camber		-1.43		0.33

Save



Alfa Romeo 166





Click "Save" button to save the vehicle specification. Click "OK".





Customized vehicle database

3.Add vehicle specifications to database

		Middle Values	Tolerance values	 166
		0.28	0.13	

Specification has been saved.9
OK

		Middle values	Tolerance values	
Single Toe		0.42	0.13	
Camber		-1.43	0.33	





←
X

Check the vehicle specification we just input as shown below. Next, drag the tool bar to the end to find the vehicle model information that was just entered.

Select vehicle specification

ACURA

Alfa Romeo

ASIA





Astonmartin

Audi

Austin

Model	Model year	Country	Chassis information	Displacement	Engine	Rim diameter
1-166	1996-2005	Italy				

Alfa Romeo 1-166





▶
◀
▶

Click “Detailed Vehicle Specification” to read the complete vehicle specification information as shown in the image below.

Vehicle detailed information

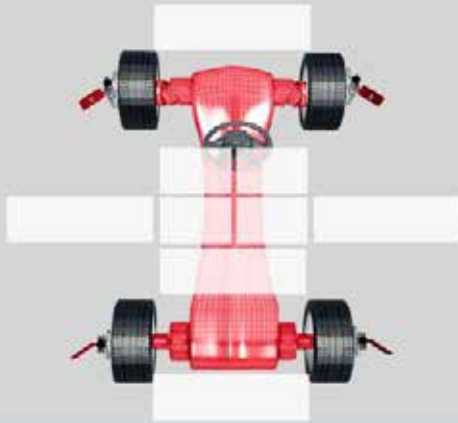

Alfa Romeo 1-166



	Min	Standard value	Max
Toe	-0°43'	-0°34'	-0°18'
Camber	-0°45'	-0°25'	-0°05'
Caster	+2°33'	+3°09'	+3°39'
KPI	+0°00'	+0°00'	+0°00'
Included angle	+0°00'	+0°00'	+0°00'
Toe/out on turn
Maximum turning angle
Maximum turning angle

	Min	Standard value	Max
Toe	+0°26'	+0°50'	+1°06'
Camber	-1°45'	-1°26'	-1°06'

X
➔

If the operator wants to input the vehicle specification by “max.value, min.value and middle value” way, please see below input way.

Customized vehicle database

3.Add vehicle specifications to database

	Max	Middle Values	Min	
Single Toe				
Camber				
Caster				
KPI				
Included Angle				



Alfa Romeo

166

0-ACURA

	Max	Middle values	Min	
Single Toe				
Camber				

Input by max.value , min. Value, and middle value
 Input by middle value, tolerance value

←
X

1. Input vehicle specification as shown below.

Max, middle values and min all must have “-“ symbol with number if it is negative.

We use above book listed on pages 117 - 118, as an example

: Toe is $0.28N \pm 0.13$.

So Max= $-0.28+0.13=-0.15$ Min= $-0.28-0.13=-0.41$ Middle values= -0.28

Customized vehicle database







3.Add vehicle specifications to database

	Max	Middle Values	Min	
Single Toe	-0.15	-0.28	-0.41	
Camber	-0.09	-0.42	-0.75	
Caster	3.65	3.15	2.65	
KPI				
Included Angle				

 Alfa Romeo

166

1-166









2. Click “Save” button to save the vehicle specification. Click “OK”.

Customized vehicle database

3.Add vehicle specifications to database

	Max	Middle Values	Min	
Single Toe	-0.15	-0.28	-0.41	
Camber	-0.09	-0.42	-0.75	
Caster	3.65	3.15	2.65	
KPI				
Included Angle				







 Alfa Romeo

166



Specification has been saved.10

OK

3. Check vehicle specification that was inputted as shown in the image below. Next drag the tool bar to the end to find the information that was just inputted.

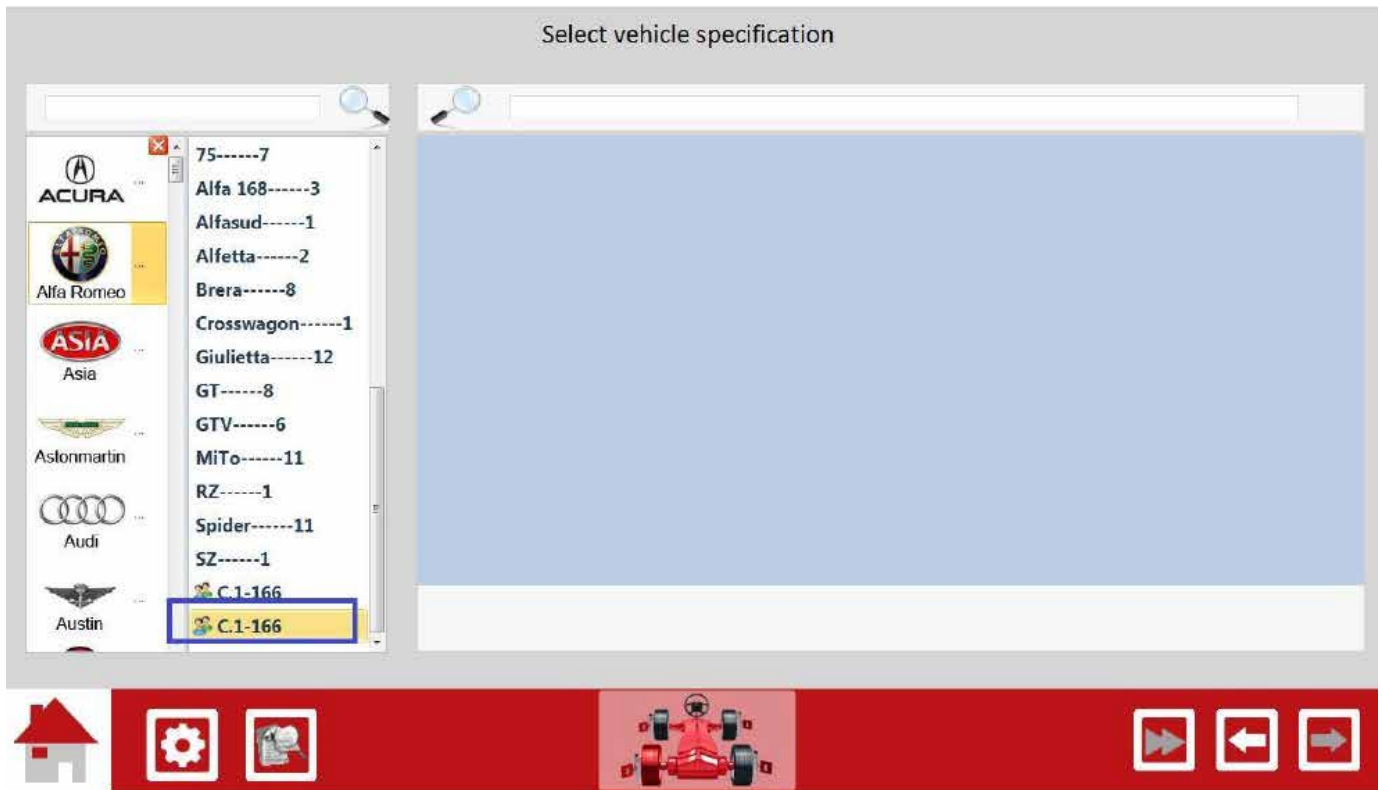

NOTE:

1. When entering vehicle specification. If the number is positive, it DOES NOT need to input “+” symbol with number. If the number is negative, it MUST input “-“ symbol with number together.
2. When entering the number, it MUST input complete. For example: the number on the book is “.09”, you must input “0.09”, CAN NOT only input “.09”.
3. When entering vehicle specification, we require to input by degree unit. So if the vehicle specification on the book is inch, you need to calculate from inch to degree. The calculation formula is:

$$\text{degree} = \text{inch} * 25.4 * 2.257 / \text{rim diameter}$$

$$4. \text{Degree} = \text{minute} / 60$$

POWER SUPPLY TROUBLESHOOTING

1. **POSSIBLE CAUSE:** Computer does not turn on, indicator on the camera beam isn't bright.

REASON: Outer power socket is not secure, or does not have power connection.
Power button on the cabinet is either turned off or is not receiving power.
Ensure that the electrical outlet is working by testing it with another device.

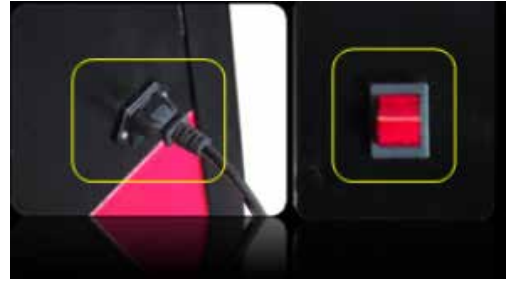

2. **POSSIBLE CAUSE:** After equipment installation, there is smoking and burning smell in the cabinet when power is connected.

REASON: Connecting with industrial power (380V), will burn the power supply. Computer also will be damaged under this situation.

SOLUTION: Ensure the voltage selection switch is set to match the power at your location, before connection. You will need to change the power supply if the above situation happens.

REASON: Connecting with industrial power (380V), will burn the power supply. Computer also will be damaged under this situation.

SOLUTION: Change the computer power.

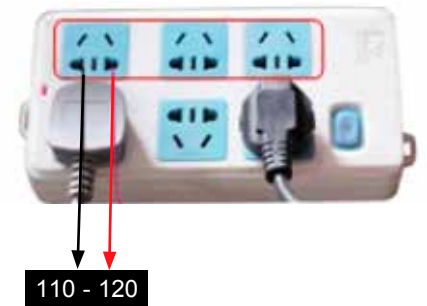

3. **POSSIBLE CAUSE:** Computer works, but camera beam doesn't have power. A demo version is played when running the 3D software program.

CHECK: The indicator of power supply is bright, if it is not bright, pull out the main power plug from HUB communication board and plug back in, then check if the indicator is bright.

REASON: If the indicator is still not bright, the power supply may not be working.

SOLUTION: Change the power supply.



CABLE CONNECTION TROUBLESHOOTING

Camera Connection Troubleshooting

POSSIBLE CAUSE: Messages will appear on the screen if there is a problem with camera connection.

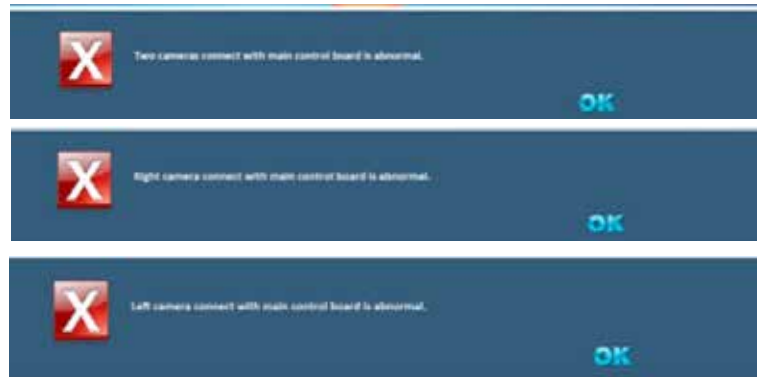

REASON: HUB communication board and camera connection are loose or camera may be broken.

CHECK: If the camera USB connection of HUB communication board is loose.

SOLUTION: Pull out and insert again.

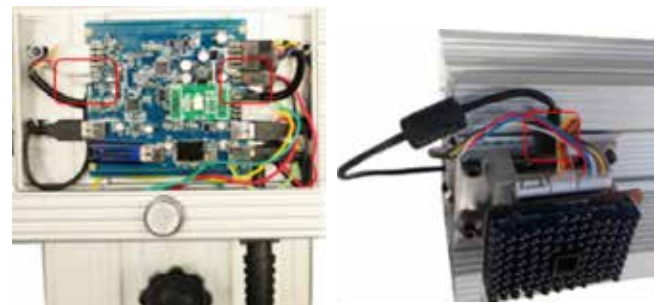

POSSIBLE CAUSE: If there are any problems with the camera connection during measurement, messages will pop up on the screen.

REASON: HUB communication board and camera connection are loose or camera may be broken.

SOLUTION: Pull out and insert again.

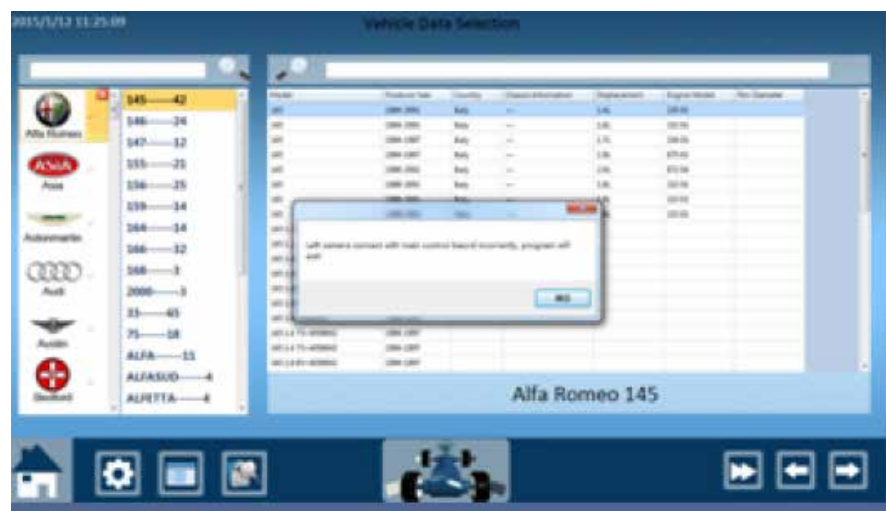

HUB COMMUNICATION BOARD TROUBLESHOOTING

POSSIBLE CAUSE: A message on your screen indicates the communication board with the PC is not connecting.



Or if the message appears during the vehicle measurement.

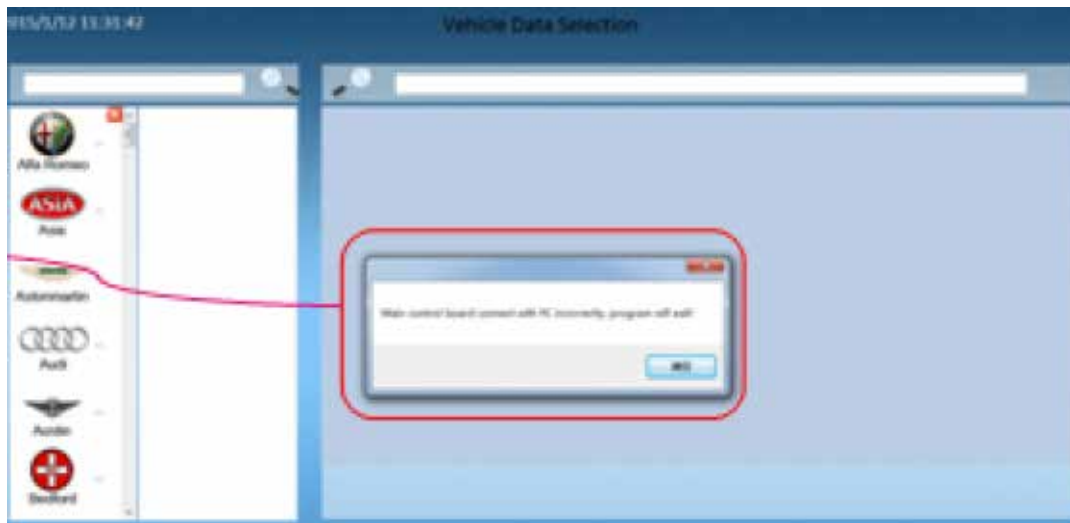

SOLUTION: The plug from the USB of the communication board is not properly connected to the PC, it may be loose or the board may be broken..

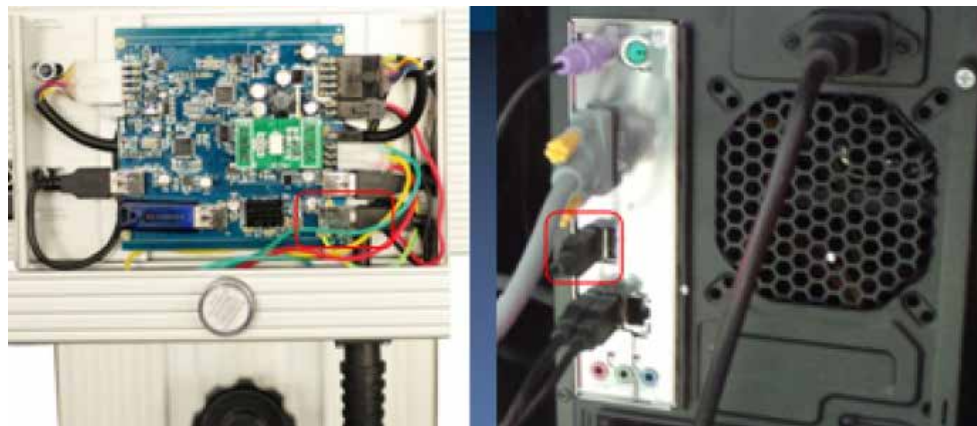



1645 Lemonwood Dr. ● Santa Paula, CA. 93060, USA
Toll Free: 1(800) 253-2363

FOR TECHNICAL SUPPORT
1-(800) 253-2363 Ext. 196
TO ORDER PARTS
1-(800) 253-2363 Ext. 191